



*THE METROPOLITAN WATER DISTRICT  
OF SOUTHERN CALIFORNIA*



---

**Advisory Panel  
for the  
Potential Regional Recycled Water Program**

**Report No. 2:  
Feasibility Methodology  
Program and Infrastructure Review  
Groundwater Basin Assumptions**

**September 18, 2016**

**Table of Contents**

**I. Executive Summary.....1**

**II. Workshop Objectives and Participants .....2**

**III. Preparation for the Workshop.....3**

**IV. Panel Charge for the Workshop .....3**

**V. Methodology for Establishing Feasibility.....4**

**VI. Comprehensive Program and Infrastructure Review .....5**

**Demonstration Facility .....6**

**Advanced Water Treatment Facility.....7**

**Conveyance System .....8**

**VII. Groundwater Basin Assumptions.....9**

**Acronyms .....13**

**Appendix – Presentations .....14**

## I. Executive Summary

The Metropolitan Water District of Southern California (Metropolitan) and the Sanitation Districts of Los Angeles County (Sanitation Districts) are considering development of a large-scale regional indirect potable reuse program for groundwater recharge in several groundwater basins. The potential Regional Recycled Water Program (Program) would begin with a proposed 0.5 million gallon per day (mgd) advanced water treatment (AWT) demonstration plant to be located at the Sanitation Districts' Joint Water Pollution Control Plant (JWPCP) in Carson. In early 2016, Metropolitan and the Sanitation Districts convened a panel of eight subject matter experts to provide independent review and critical input on the scope and direction of the Program for the demonstration project and development of the feasibility study for a full-scale AWT facility and conveyance system.

At the first workshop on March 31 and April 1, 2016, the Advisory Panel reviewed the overall program and engaged the Project Technical Team in an in-depth discussion of the demonstration plant design. The Project Technical Team consists of Metropolitan staff, Sanitation Districts staff, and consultant staff. The Advisory Panel's report is available on Metropolitan's website.

The second workshop was held July 27-28, 2016. The focus was on the approach to determining overall program feasibility, including methodology, infrastructure, and groundwater basin assumptions. The panel considered the approach and methodology for determining feasibility. This included a defined base case and assumptions for a 150 mgd AWT facility and conveyance system to deliver water for groundwater recharge to four groundwater basins within Metropolitan's service area. The Advisory Panel was asked to focus on two key questions raised in the feasibility analysis:

- 1) Is it technically and institutionally possible to implement a 150 mgd indirect potable reuse program using effluent from the JWPCP?
- 2) Are the costs and benefits of the program consistent with Metropolitan's 2015 Integrated Water Resources Plan (IRP) and other approaches for achieving a comparable amount of recycled water?

The Advisory Panel concurred with the overall approach to evaluating feasibility and stated that the proposed report outline and draft working documents were sound pending the incorporation of workshop input. The Advisory Panel encouraged the inclusion of all key assumptions and a description of associated risks and mitigation measures.

The Advisory Panel also considered the program infrastructure and whether the base case program adequately addressed all the critical requirements needed to evaluate program feasibility. The panel discussed the demonstration facility, full-scale AWT facility, and conveyance system. The panel generally concurred with the assumptions and approach, and provided recommendations for each of the program elements.

The Advisory Panel also considered the groundwater basin analysis and assumptions. The panel concurred that the use of calibrated groundwater flow models to assess potential changes in groundwater levels and flow that could result from the project is a reasonable initial investigation and should be followed up with additional studies. The three models currently being used to evaluate the project have been calibrated and documented and have previously been used to support basin management decisions. The model results of potential project operations in the Main San Gabriel Basin and the Central/West Coast Basins were not available at the time of the workshop and are, thus, still subject to review. However, the general approach Metropolitan has taken in using these modeling tools to evaluate potential project impacts is appropriate.

## II. Workshop Objectives and Participants

The Advisory Panel met on July 27-28, 2016 to review the potential Regional Recycled Water Program proposed jointly by Metropolitan and the Sanitation Districts. The purpose of the workshop was to consider the approach to determining overall program feasibility, including methodology, infrastructure, and groundwater basin assumptions.

The following members of the Advisory Panel participated:

Richard Atwater (Co-chair)	Expert on recycled water programs
Shivaji Deshmukh	Assistant General Manager, West Basin Municipal Water District
Thomas Harder	Thomas Harder and Company (Hydrogeology)
David Jenkins	Professor Emeritus, University of California, Berkeley
Edward Means	President, Means Consulting LLC
Joseph Reichenberger	Professor, Loyola Marymount University
Paul Westerhoff	Professor, Arizona State University
<i>Excused:</i> Margaret Nellor (Co-chair) Nellor Environmental Associates, Inc.	

In addition to the panelists, the following members of the districts' management and Project Technical Team participated:

Paul Brown	Program Manager, Metropolitan
Renee Hoekstra	Facilitator, Metropolitan

**Metropolitan:** Debra Man, Gordon Johnson, Jim Green, John Bednarski, Brad Coffey, Gloria Lai-Blüml, Kimberly Wilson, Jay Arabshahi, Matt Hacker, Mickey Chaudhuri, Sun Liang, Carolyn Schaffer, June Skillman, Taylor Machado, Evelyn Ramos, Tom Hibner, Barbara Rogers

**Sanitation Districts:** Grace Hyde, Robert Ferrante, Rob Morton, Martha Tremblay, Shannon Bishop, Ann Heil, Phil Friess

**Consulting Design Team:** James Borchardt, Eric Mills, Zakir Hirani, Shane Trussell, Adam Zacheis, Gary Meyerhoffer, Hannah Ford, Michael Adelman

### III. Preparation for the Workshop

Prior to the meeting, the Advisory Panel was provided with a series of working documents related to the following:

- Feasibility Approach and Methodology
- Full-Scale Advanced Water Treatment Facility
- Recycled Water Conveyance System
- Groundwater Basins Evaluation

The working documents were developed around a “base case” that is being used for the analysis and evaluation, defined as follows:

*The base case is an implementable system of program elements, including facilities, infrastructure, institutional arrangements, and financing assumptions (each of which have quantifiable and acceptable levels of risk) that are necessary and sufficient for accomplishing the program objectives of indirect potable reuse. It is a hypothetical system model that has not yet been designed to achieve “optimized performance” but is deemed capable of accomplishing the program’s functional goals.*

*The base case is not designed to handle peak flows to the JWPCP. The base case facilities are expected to periodically reduce deliveries to groundwater basins when conditions warrant.*

*Finally, the base case system should not be considered as either the “best” or the “worst” case scenario with respect to implementation costs or timelines. It represents a realistic approach to achieving the program’s functional goals and is intended to demonstrate “feasibility” only.*

The base case is intended to provide delivery flexibility with a design flow of 150 mgd, average daily deliveries of 144 – 150 mgd and a minimum delivery of approximately 110 mgd.

### IV. Panel Charge for the Workshop

The Advisory Panel was charged with the following series of questions for this workshop:

#### 1) Methodology for Establishing Feasibility

- Are the essential elements that must be considered for evaluating program “feasibility” being addressed?
- Are there recommended improvements to the approach for assessing feasibility?
- Is there additional information that should be provided?

**2) Comprehensive Program and Infrastructure Review**

- Has the base case program adequately addressed all the critical requirements needed to evaluate program feasibility?
- What aspects of the program present the greatest risk, uncertainty, and vulnerability?
- What can be done to improve overall program feasibility?

**3) Groundwater Basin Assumptions**

- Are there specific groundwater basin issues or concerns that should be acknowledged and/or addressed in the feasibility study?
- What are the advantages/disadvantages of providing a guaranteed annual replenishment supply for the regional groundwater basins?

Metropolitan updated the Advisory Panel on the status of the feasibility study and provided presentations on the key topics for the workshop. The panel presentations are included in the Appendix available on Metropolitan’s website.

**V. Methodology for Establishing Feasibility**

The Advisory Panel was asked to provide comments on 1) whether the essential elements to determine feasibility, as described below, are appropriately considered; 2) recommended improvements to the approach; and 3) additional information that should be provided in the feasibility study.

The Advisory Panel focused on two key questions raised in the feasibility analysis:

- 1) Is it technically and institutionally possible to implement a 150 mgd indirect potable reuse program using effluent from the JWPCP?
- 2) Are the costs and benefits of the program consistent with Metropolitan's 2015 Integrated Water Resources Plan (IRP) and other approaches for achieving a comparable amount of recycled water?

To simplify the feasibility analysis, and to avoid analyzing and evaluating a myriad of possible program alternatives, a base case was developed that would meet the program goals. The base case includes a 150 mgd “demand-driven” AWT facility. This facility would be able to periodically ramp down production for delivery flexibility. It would not be designed to manage peak flows at the JWPCP. Based on the analysis, 110 mgd or more can be consistently delivered to the various spreading basins and injection wells, with 150 mgd delivered 85 percent of the time. No new spreading facilities are assumed to be needed.

The current wastewater flow at the JWPCP has dropped significantly due to water conservation. Although the JWPCP has a design capacity of 400 mgd, current (2015) average daily flow is 265 mgd. The daily minimum is 150 mgd; the daily peak is 350 mgd. With an estimated recovery of 85 percent,

the AWT plant will need a minimum inflow of 180 mgd to produce 150 mgd of product water. Since the current minimum flow to the JWPCP is 150 mgd, flow equalization will be needed.

### ***Advisory Panel Comments***

The Advisory Panel concurred with the approach to evaluating feasibility and stated that the overall approach in the report outline and draft working documents is sound. The panel provided the following comments for consideration.

***Direct Potable Reuse.*** The Advisory Panel discussed whether direct potable reuse (DPR) should be included in the base case, in addition to indirect potable reuse (IPR) through groundwater recharge. There is now a clearer regulatory path to future DPR, (e.g. the state has issued a draft feasibility study), and Metropolitan should be prepared for this eventuality. The panel acknowledged that DPR may not address the regional water supply reliability problem as effectively as storage in the groundwater basins. These basins provide a large share of the region's storage, and their availability is built into regional reliability assumptions. The demonstration plant data could help to evaluate the feasibility of future DPR even though regulations may still be ten years or more away. The report should describe how IPR projects would contribute to meeting future DPR standards and indicate how Metropolitan would be contributing to the development of this body of knowledge.

***Program Implementation.*** The Advisory Panel stated that phasing the project to minimize the risk of stranded investments should be evaluated. In addition, planning should be coordinated with other projects to prevent overlapping planning for water demands and potential duplication of facilities. Development of other projects could impact demand for the program water.

Public outreach and environmental justice issues need to be considered and addressed. Panel members pointed out that the Orange County Water District (OCWD) has successfully addressed these issues through comprehensive outreach and education for the Groundwater Replenishment System (GWRS).

Stormwater capture is currently a major initiative throughout Southern California and has led to major ongoing and planned capital expenditures. Dovetailing with this initiative would provide additional regional-scale benefits.

## **VI. Comprehensive Program and Infrastructure Review**

The Advisory Panel was asked to provide comments on 1) whether the base case adequately addresses all the critical requirements needed to evaluate program feasibility; 2) aspects of the program that present the greatest risk, uncertainty, and vulnerability; and 3) recommendations to improve overall program feasibility.

### **Demonstration Facility**

When the Advisory Panel met, work on the demonstration plant was at the 50 percent design stage. Preliminary cost estimates indicated that the original 1 mgd demonstration plant concept would not likely be constructed within the original program budget authorization of \$15 million. To keep the program within budget and not compromise objectives, the demonstration plant was re-sized for 0.5 mgd. This change retained the full functionality for testing at a more reasonable cost.

An updated demonstration plant process train was presented to the Panel.

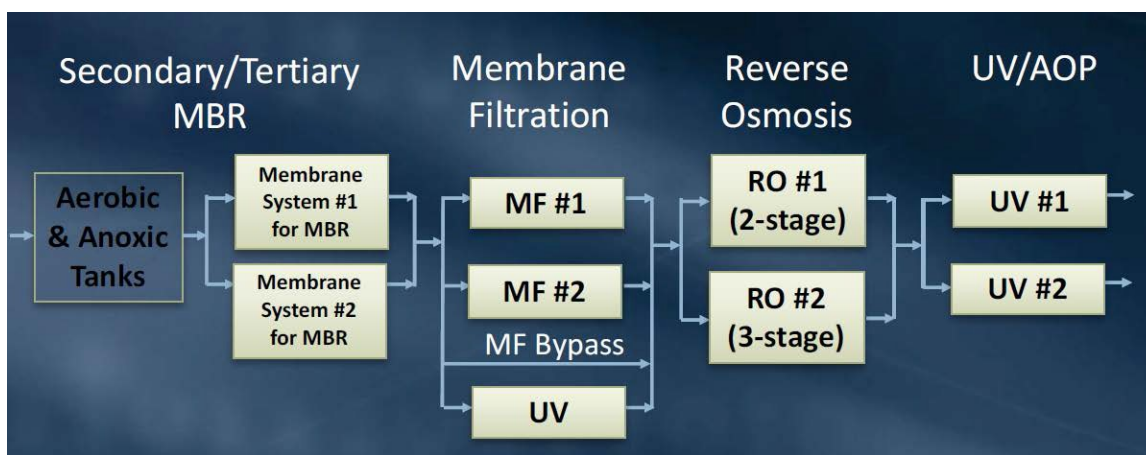

**Advisory Panel Comments.** The demonstration plant will use a two-pass RO system and a three-pass RO system in parallel for comparison. The panel agrees that the product water quality from either the two-pass RO system or the three-pass RO system will be similar.

The Advisory Panel questioned having two equipment vendors for each process when the trains are not separate. The Advisory Panel recommends that the Design Team confirm that the regulators are comfortable with there being more than one equipment vendor for each process.

The Advisory Panel suggests consideration of a short aerated zone upstream of the membranes to avoid anoxic water going directly to the membranes and creating risks of fouling.

The Advisory Panel agrees with the Design Team that the demonstration plant will be able to use several carbon sources (methanol and MicroC2000™). The treatment process should also include a phosphoric acid feed to prevent the biological process from being phosphorus limited.

The Advisory Panel recommends that the feasibility study include a discussion of how the demonstration facility fits into the program. It will confirm key assumptions and demonstrate the technology for the regulating agencies and the public. It will provide the design information for the first large-scale facility treating non-nitrified secondary effluent.



### ***Advanced Water Treatment Facility***

The base case includes a 150 mgd AWT facility located at the JWPCP. A conceptual site layout of the full-scale AWT facility was presented. There is space available for the facility within the existing JWPCP property with space for future expansion. Three dimensional renderings of major facilities in the AWT facility were presented.

The base case assumes that sidestream centrate treatment and flow equalization will be provided to improve the quality of the influent to the AWT plant and ensure a constant flow. The proposed treatment train for the AWT facility includes a membrane bioreactor, reverse osmosis, and advanced oxidation (MBR-RO-AOP) followed by stabilization with lime and carbon dioxide (CO<sub>2</sub>), then finally chlorination, before the treated water is pumped into the conveyance system. This treatment train is expected to achieve more than the required 12 log virus/10 log *Giardia*/10 log *Cryptosporidium* removal/inactivation (12/10/10) without MF. This treatment approach assumes that the treatment processes used in the demonstration facility receive regulatory approval for use in the full-scale facility.

In the base case, the water quality goals for nitrogen will be met through sidestream centrate treatment at the JWPCP along with partial NdN, tertiary membrane bioreactor (tMBR) treatment following the existing secondary treatment at the AWT, and rejection of nitrate by RO. MicroC2000™ could be used as the carbon source for NdN. Satellite ion exchange (IX) or retrofit of JWPCP with NdN are alternative nitrogen management options. The Design Team is evaluating nitrogen management alternatives in coordination with the Sanitation Districts.

In the base case, boron loading will be reduced through source control with no additional treatment process at the AWT plant. If this is not achievable, satellite IX facilities or diluent water credit could be pursued with the groundwater basin managers and the regulatory agencies.

The AWT facility would be designed with spare/redundant equipment to achieve greater than 98 percent online time.

***Advisory Panel Comments.*** The Advisory Panel recommends that operational water quality targets be established for the AWT source water. This includes influent and secondary effluent water quality, source control measures, boron, nitrogen, and water chemistry/blending. In this context, the panel asked if there had been any progress on boron source control. The Sanitation Districts responded that sampling is underway by their industrial waste staff. Sixty-five different possible dischargers had been identified. The panel asked if space should be allocated for ion exchange facilities (IX). The Design Team responded that it is anticipated that treating the full flow by IX would be cost-prohibitive, so satellite facilities treating only a small part of the flow would be used if needed. The Design Team stated that space would be set aside at the demonstration facility so that pilot-scale IX testing could be conducted on an as-needed basis.

The Advisory Panel thought it might be too optimistic to exclude MF/UF after the MBR in the base case and encouraged the Design Team's current plan to have the demonstration plant provide the data both with and without MF in the treatment train. The panel supports the decision to allocate space for future MF in the full-scale layout if needed. This could also provide for the addition of MF to meet future potential DPR requirements.

The Advisory Panel commented that it may be appropriate to divert denitrified water, prior to RO-treatment, for non-IPR use near the JWPCP.

The Advisory Panel asked about where the secondary effluent flow equalization basin would be located. The Sanitation Districts indicated that flow equalization is still being evaluated. Existing clarifiers that are not needed for current reduced flow could potentially be used. The Advisory Panel inquired whether tankage used for equalization could also be used to start the process of nitrification by adding fixed-film media, air, and return secondary solids. The Design Team responded that this would be considered in future studies.

The need for flow equalization in the future was discussed. Based on the flow rates experienced at JWPCP currently and as anticipated with ongoing conservation efforts, flow equalization may be needed to operate the plant at a constant flow rate of 150 mgd initially. However, as flows increase due to population growth, it is possible that flow equalization may not be needed at some point in the future. The Advisory Panel recommends that the trend of decreasing wastewater flows due to conservation be considered in planning the ultimate capacity of the AWT.

The Advisory Panel inquired about the acceptability of brine stream discharge from the full-scale AWT facility into the Sanitation Districts' permitted ocean discharge. The Sanitation Districts responded that they will assess this during the demonstration project and coordinate with the Regional Water Quality Control Board. Toxicity is critical because there may be constituents that could become an issue when concentrated in the brine discharge.

The Advisory Panel recommends that the planning process assess energy consumption and sources. AWT is an energy-intensive process and the issue of carbon emissions will arise.

### ***Conveyance System***

A schematic map of the conveyance system to deliver the water to the groundwater basins was presented. It included points of discharge to recharge basins in the Main San Gabriel Basin to the northeast and the Orange County Basin to the east. A range of flows to be conveyed to spreading grounds at Santa Fe, Rio Hondo, and Orange County, along with injection wells at West Coast Basin, Long Beach, and Central Basin were shown. The goal of the conveyance system analysis was to identify potential alignments using public rights-of-way to the extent possible and to minimize impacts on utility relocation, traffic, etc. Alignments were evaluated using a matrix based on environmental,

constructability and real property criteria. The base case includes three pump stations and about 54 miles of new pipeline ranging from 60 to 84 inches in diameter.

**Advisory Panel Comments.** The Advisory Panel noted that two Metropolitan surface water treatment plants are relatively close to the conveyance lines as shown in the base case. The panel suggests that at some future time and, with DPR regulations permitting, connection to existing Metropolitan raw water pipelines and ultimately the treatment plants may be possible. This would enhance the operational flexibility when full spreading capacity may not be available.

The Advisory Panel commented that the base case conveyance system is proposing cement mortar-lined pipes, which have been a problem for OCWD. Even if the AWT facility is designed to produce stable water quality with post-conditioning, this is not always achieved in practice and a robust conveyance material is important. The panel suggested use of high density polyethylene pipe, but this material has size and pressure limitations. Fiberglass pipe, per AWWA C-950, may be suitable; it is available in large diameters and various pressure classes. The panel also noted that activated sludge effluent is aggressive and must be accounted for in the materials and budgeting. The panel recommends that a robust, non-corrosive pipeline material or lining *in lieu* of cement mortar lined steel be considered during design.

The Advisory Panel agrees with the assumption in the base case that new injection wells should be stainless steel to avoid issues with corrosion and plugging.

The Advisory Panel recommends that planning for the conveyance system should be flexible and account for future possible sources of water such as other reuse projects, desalination, DPR, etc. The conveyance system must be coordinated with existing water supply and recycled water facilities, other planned projects, and other possible sources, including the conveyance for the Water Replenishment District's Groundwater Reliability Improvement Project. Since these projects are likely to occupy the same space along the San Gabriel River levee, there may be a potential for joint ownership. Coordination with the Los Angeles County Flood Control District, Army Corps of Engineers, other utilities and cities will be needed during conveyance system planning.

## **VII. Groundwater Basin Assumptions**

The Advisory Panel was asked to provide comments on 1) specific groundwater basin issues or concerns that should be acknowledged and/or addressed in the feasibility study, and 2) the advantages and disadvantages of providing a guaranteed annual replenishment supply for the regional groundwater basins.

The general approach to evaluating groundwater recharge feasibility in the base case includes:

- Demand Analysis – Is there sufficient demand for recharge water?
- Operational Assessment – Are there operational issues that may limit how much can be recharged?
- Groundwater Modeling – What are the impacts of recharge and extraction of project water?
- Facility Needs – Are additional facilities required?

Metropolitan has met with member agencies and basin managers to discuss the program. The agencies and basin managers provided data and information to assist with the evaluation. Metropolitan, in coordination with the basin managers and spreading basin operators, evaluated a range of groundwater recharge needs, demand, available spreading basin capacity and diluent water availability. Urban runoff and stormwater are percolated in the same spreading grounds during the rainy season. For the West Coast Basin, the water would be used for recharge through new injection wells as well as to meet refinery demands.

For the operational assessment, the base case assumes that spreading capacity at the recharge basins would be available at least 95 percent of the time. Metropolitan also assumed that diluent water (i.e. a blending water source) would be required in the initial three years of recycled water recharge.

Potential impacts from recharge and extraction of project water are being studied using groundwater flow models. Three pre-existing models are being utilized, each under the oversight of the respective basin managers: Central Basin under contract with Water Replenishment District (WRD); Main San Gabriel Basin under contract with Main San Gabriel Basin Watermaster; and Orange County Basin operated by the Orange County Water District. At the time of the workshop the Orange County Basin analysis had been completed with the analyses of the Central Basin and Main San Gabriel Basin underway and not available to the panel.

The normal operations assumed for the base case of 150 mgd are as follows: up to 62 mgd to Main San Gabriel Basin; up to 11 mgd to Central Basin at Montebello Forebay/Rio Hondo Spreading Grounds; up to 4 mgd to injection wells at Long Beach; up to 15 mgd to West Coast Basin through new injection wells; and 58 mgd to Orange County Basin. The deliveries during wet periods, with a minimum of 110 mgd, are as follows: up to 77 mgd to Main San Gabriel Basin; up to 18 mgd to Orange County Basin; and up to 15 mgd to West Coast Basin.

### ***Advisory Panel Comments***

**Groundwater Modeling.** The use of calibrated groundwater flow models to assess potential changes in groundwater levels and flow that could result from the project is reasonable and prudent. The three models currently being used to evaluate the project have been calibrated and documented and have previously been used to support basin management decisions. The model results of potential project operations in the Main San Gabriel Basin and the Central/West Coast Basins were not available at the time of the workshop and are, thus, still subject to review. However, the general approach Metropolitan has taken in using these modeling tools to evaluate potential project impacts is necessary and appropriate.

The Advisory Panel asked about the basis for the probabilities of recharging these flows and if wet/dry rotations of the basins were considered. Metropolitan stated that a detailed analysis was conducted using historic data from each basin. Wet and dry periods were included in the analysis.

The Advisory Panel asked whether diluent water from other sources was considered in the analysis of the proposed recharge sites. Metropolitan responded that this was taken into consideration in the analysis. The capacities at each basin are ultimate build-out capacities, and the modeling accounts for ramp-up using diluent water.

The Advisory Panel asked about the criteria for determining that 15 mgd could be delivered to the West Coast Basin. Metropolitan responded that the 15 mgd is based on unused capacity within the basin adjudication. The Advisory Panel commented that, in the West Coast Basin service area, taking imported water is easier and less costly than building wells. The base case assumes that pumpers in the West Coast Basin will increase production of their groundwater wells; however, assuming increased production is a potential risk. The location of the increased pumping could be affected by the location of the intruded sea water in the West Coast Basin and extraction and brackish water desalination may be required. The WRD is studying expanding brackish water desalination, and the injection of program water will need to be coordinated with WRD to optimize pumping in the West Coast Basin. Over time, pumping groundwater will likely cost less than direct deliveries of treated imported water. In the feasibility report, the planned flows should be described as ranges (e.g., 0-15 mgd) pending formalization of the flows with the basin managers.

**Groundwater Contamination.** The Advisory Panel commented that there are potential issues with recharging water in one place and producing from wells in other locations. The issues may arise from movement of a pollutant plume or mounding of groundwater around the injection site with depression around production wells, (“pumping hole”), depending on the ability to move water underground. A risk strategy needs to be considered for potential movement of Superfund and other contaminant plumes in the various basins.

The Advisory Panel noted the particle tracking work presented with the groundwater basin analysis. This was done to understand where the water goes when it is injected or spread into each basin, and to evaluate local issues (plume movement, potable water well impacts, etc.), that may result from replenishment. A six-month travel time from recharge to nearest production well is currently required by regulations. This travel time needs to be confirmed for injection into a confined aquifer. Additional analysis may be needed.

The Advisory Panel raised the issue of water losses in the basins. It was stated that basins have roughly a 3-6 percent loss on average. The panel agrees with Metropolitan’s response that this issue is best addressed in the next/upcoming phases of the program via detailed groundwater modeling and documented along with other groundwater impacts.

The Advisory Panel noted that experience in Florida and elsewhere has shown that as a plume of low-TDS water enters the basin from IPR injection, it can mobilize naturally occurring geochemical constituents in the soil (e.g. arsenic). The Design Team indicated that some alkalinity addition as part of the post-stabilization step may be required to avoid mobilizing geochemical constituents in the soil

during recharge. In addition, Metropolitan has been talking to groundwater basin managers about their experience with this in their basins.

***Recharge Operations and Maintenance.*** Metropolitan is proposing to operate the AWT facility by ramping down to 110 mgd under wet weather conditions. This will allow the groundwater basins to recharge stormwater. The report should address wet weather operation of each groundwater basin since it is likely to vary from basin to basin.

Recharge in the Main San Gabriel Basin could eventually be limited by a maximum key well groundwater level above which replenishment with recycled water is not allowed (particularly in wet years like 1998 and 2004). This is an existing limit driven by agreements with the sand and gravel producers. The groundwater modeling for the Main San Gabriel Basin should account for this.

The Advisory Panel noted that there may be environmentally sensitive habitat issues associated with taking the basins offline for maintenance at some locations during certain times of the year. All basins need to be assessed for such habitat issues.

At existing locations where blended stormwater and AWT water will be recharged into the same basin, chemical effects that are difficult to predict may occur due to the blending of these water sources. Water quality modeling should look at stability and possible dissolution or precipitation. As water levels in the basins increase, nitrate leaching could be a greater issue than arsenic leaching.

Although reduction of infiltration has taken place in other locations due to swelling of clay minerals driven by ion exchange reactions, the existing recharge basins proposed for use in the program have not shown or documented this tendency.

***Potential Regional Benefits.*** The Advisory Panel discussed the benefits of providing this water for groundwater recharge in the region. The program provides water that can be stored underground (i.e. in the aquifer) for supply during emergencies. In the event of an outage, earthquake, etc., this project is comparable in water supply significance to Diamond Valley Lake and provides a benefit in the form of avoided cost for building reservoir storage. Water quality improvement and salinity management for groundwater basins is an important benefit in counteracting salt accumulation. A firm supply of low-TDS water is a valuable regional asset.

**Acronyms**

AOP	advanced oxidation process
AWT	advanced water treatment
DPR	direct potable reuse
GWRS	Groundwater Replenishment System
IPR	indirect potable reuse
IRP	Integrated Water Resources Plan
IX	ion exchange
JWPCP	Joint Water Pollution Control Plant
MBR	membrane bioreactor
MF	microfiltration
mgd	million gallons per day
NdN	nitrification and denitrification
OCWD	Orange County Water District
RO	reverse osmosis
tMBR	tertiary membrane bioreactor
TDS	total dissolved solids
UF	ultrafiltration
UV	ultraviolet (disinfection)
WRD	Water Replenishment District

**Appendix - Presentations**

- Demonstration Facility
- AWT Facility
- Conveyance System
- Groundwater Analysis Methodology



# Recap of Panel Recommendations for Demo Plant

# Demo Plant Design

- Should UV/AOP and IX be tested on combined effluent from two trains?
  - Two parallel UV/AOP systems will be tested
  - Pilot testing area will be provided for IX and post-stabilization

# Demo Plant Design

- Is the approach to nitrogen management appropriate?
  - Two parallel MBR systems will be tested
  - Biological NdN (w/ partial denitrification) and nitrate trimming using downstream RO
  - Varying degrees of denitrification will be tested – MBR effluent nitrate of <2.5 to 50 mg/L-N
  - Design TKN concentration of 50 mg/L-N with ability to treat up to 58 mg/L-N

# Demo Plant Design

- Is the approach to boron management appropriate?
  - Pilot testing area will be provided for sidestream IX
  - Assume boron will be managed at the source or treated prior to recharge at MSG Basin
- Should the demo plant unit processes be selected based on scalability to 150 mgd?
  - Selected processes are generally scalable

# Demo Plant Design

- Is the equipment procurement strategy appropriate?
  - Demo plant vendors will be prequalified
  - General Contractor will purchase equipment
  - Vendor prequalification for full-scale equipment will be separate
  - Turnouts will be provided to allow future testing and validation for full-scale equipment

# Original Demo Plant Configuration

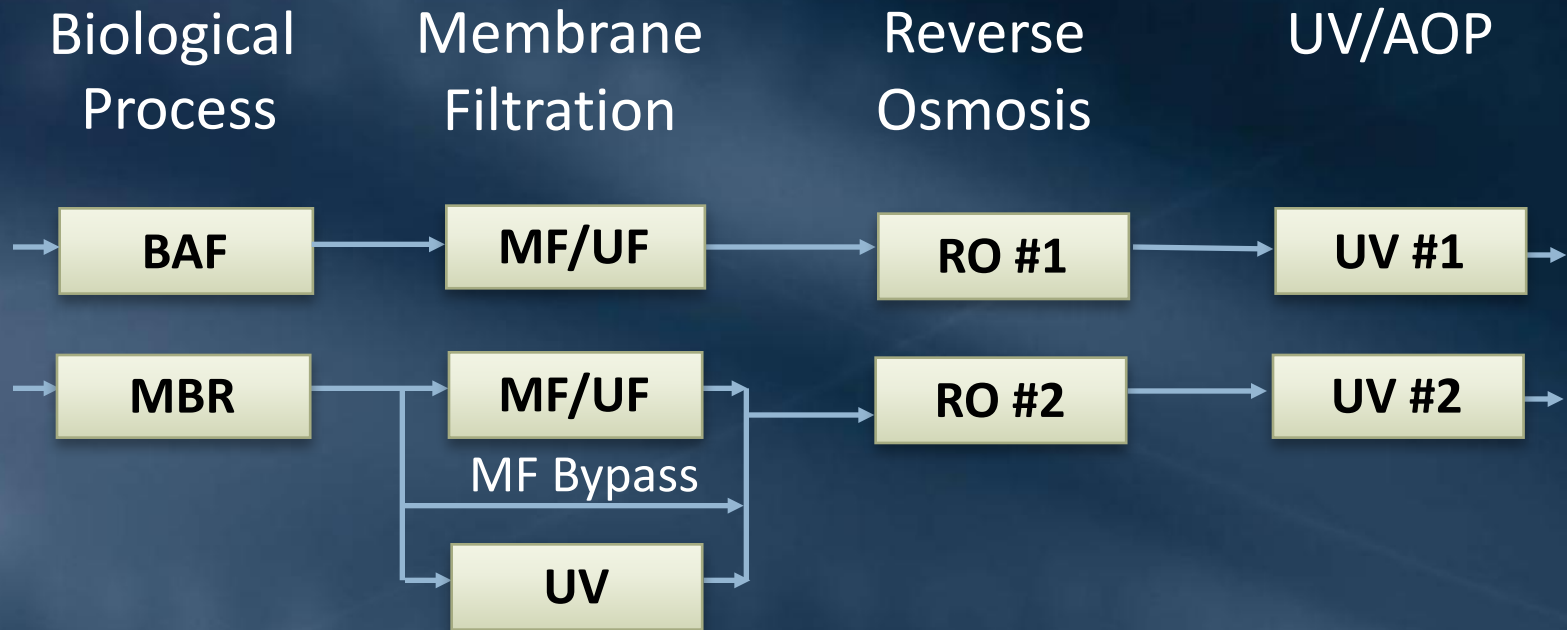

- 1 MGD Product Flow Design Capacity
- Two Process Trains with Different Biological Pretreatment: MBR & BAF

# Current Demo Plant Configuration

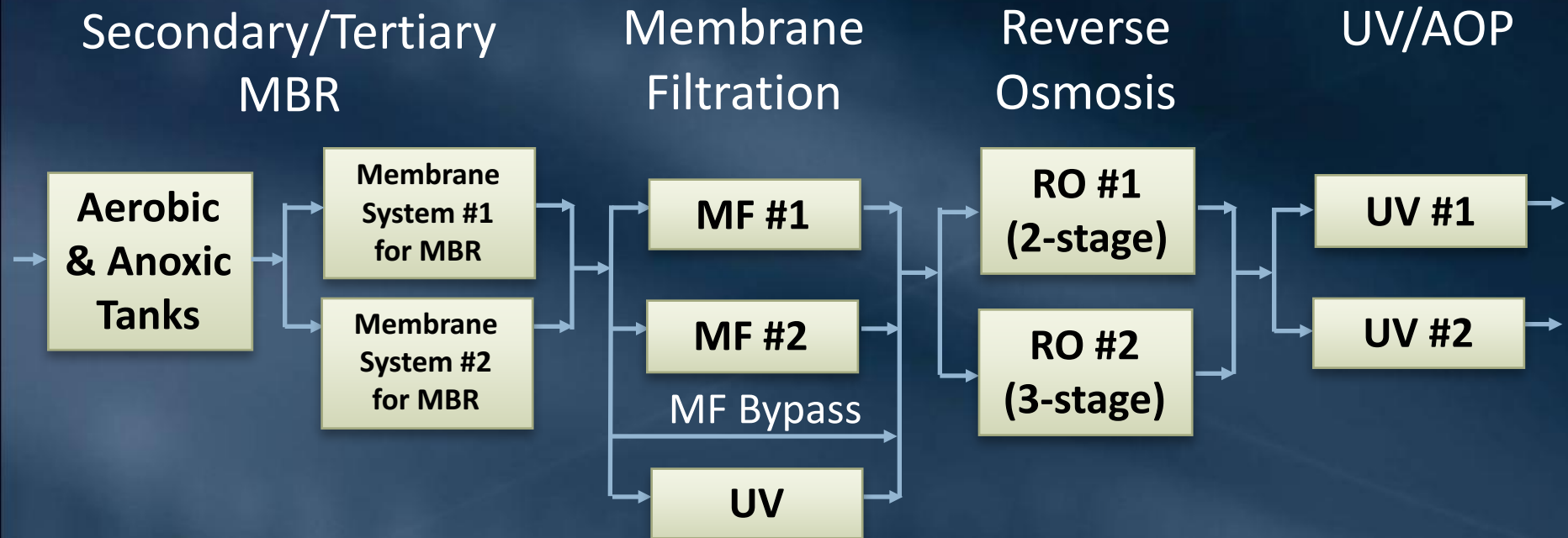

- 0.5 MGD Product Flow Design Capacity
- Two treatment systems for each unit process
- Ability to treat either Primary or Secondary Effluent

# Demo Plant Layout

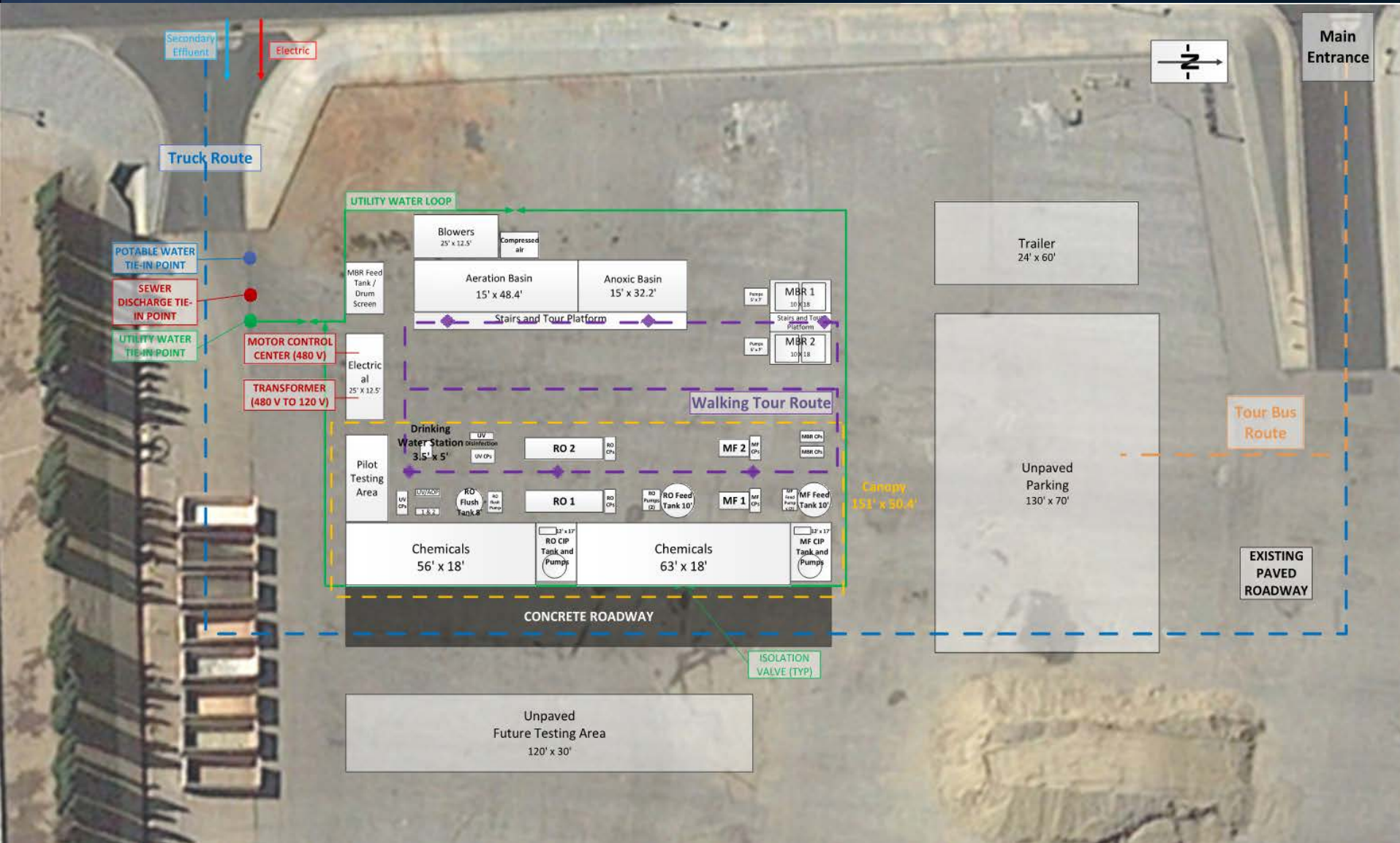





# Full-Scale AWT Base Case

Advisory Panel Meeting No. 2  
July 27, 2016

# Location of AWT Facilities at JWPCP



Demo  
Plant Site

Full-Scale  
AWT Site

N

Feet

bing

Service Layer Credits: Image courtesy of USGS | Image courtesy of LAR-IAC Earthstar Geographics SIO © 2016 Microsoft Corporation

J:\Projects\Water\_Reuse\_Purification\GIS\H2OPur\_JWPCP\_Property\_20160229.mxd [Printed 2/29/2016] Photography Date: BING Prepared by: Enrique Chen (Geodetics & Mapping Team) Checked by: Kimberly Wilson Job#: GIS16-02-29

# Full-Scale AWT Base Case Overview

- Receive unchlorinated , non-nitrified secondary effluent from Joint Water Pollution Control Plant (JWPCP)
- Produce high-quality water suitable for groundwater recharge
  - 150 mgd product water design capacity
  - Meet current basin objectives
- Use tertiary MBR (tMBR) to achieve pathogen log reduction and minimize membrane fouling

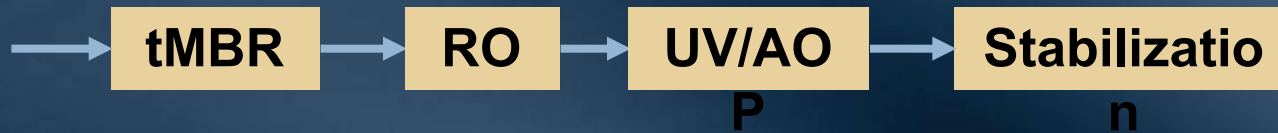

# Full-Scale AWT Base Case Schematic

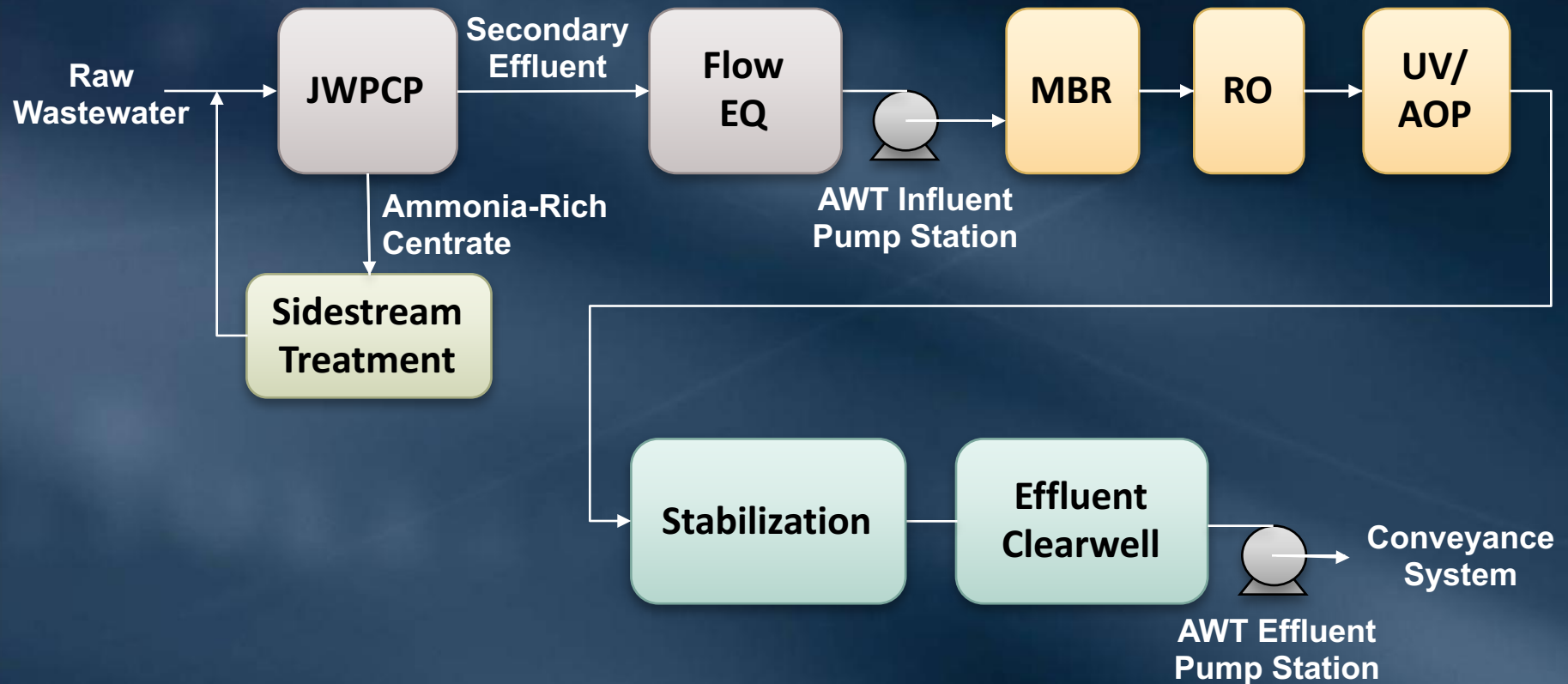

# Achieving MBR Log Removal Credits

- DDW requires 12/10/10 log removal of virus/*Crypto*/*Giardia* for indirect potable reuse using FAT process train
- MBR expected to achieve at least 2.5 pathogen log removal
- Pressure decay test or other surrogate testing required to demonstrate membrane integrity

Unit Process	Log Removal Credits (virus / <i>Crypto</i> / <i>Giardia</i> )
<b>MBR</b>	<b>0.0 / 2.5 / 2.5</b>
RO	1.5 / 1.5 / 1.5
AOP	6.0 / 6.0 / 6.0
Free Chlorine	6.0 / 0.0 / 0.0
<b>Total</b>	<b>13.5 / 10.0 / 10.0</b>





# Nitrogen Management

- Issue:
  - Treatment required to reduce nitrate prior to recharge
- Base Case:
  - Sidestream ammonia treatment at JWPCP
    - Achieve 20% nitrogen reduction
  - Nitrification and Partial Denitrification w/ tMBR
    - Achieve 12 mg/L-N in MBR effluent
  - 80% denitrification w/ RO process at AWT
    - Achieve < 3.4 mg/L-N in AWT effluent
  - Requires external carbon source

# Nitrogen Management

- Alternatives to the Base Case:
  - Satellite IX prior to discharge at Orange County Basin
  - Retrofit JWPCP secondary basins to provide NdN
- Nitrogen Management Options:

<b>Nitrification Only @ AWT + Satellite IX</b>	<b>Nitrification Only @ JWPCP + Satellite IX</b>
<b>Nitrification and Partial Denitrification @ AWT (Base Case)</b>	<b>Nitrification and Partial Denitrification @ JWPCP</b>



# Boron Management

- Issue:

- Treatment and/or source control measures needed to reduce boron levels prior to recharge

- Base Case:

- Source control may provide most cost-effective and practical solution for boron reduction
- RO process at AWT removes remaining boron for compliance with effluent limits

# Boron Management

- Alternatives to the Base Case:
  - Satellite IX prior to discharge at Main San Gabriel Basin
  - Seek revision of basin objective

# Summary of Base Case Assumptions

- At JWPCP
  - Sidestream ammonia treatment
  - Flow equalization provided upstream of AWT
- At AWT
  - Nitrification + Partial Denitrification w/ tMBR
  - MicroC2000 as carbon source
  - MBR to achieve sufficient pathogen log reduction credit without membrane filtration
  - 3-stage RO
  - Post-Stabilization with lime and CO<sub>2</sub>

# Full-Scale 150 MGD AWT



# Influent Pump Station

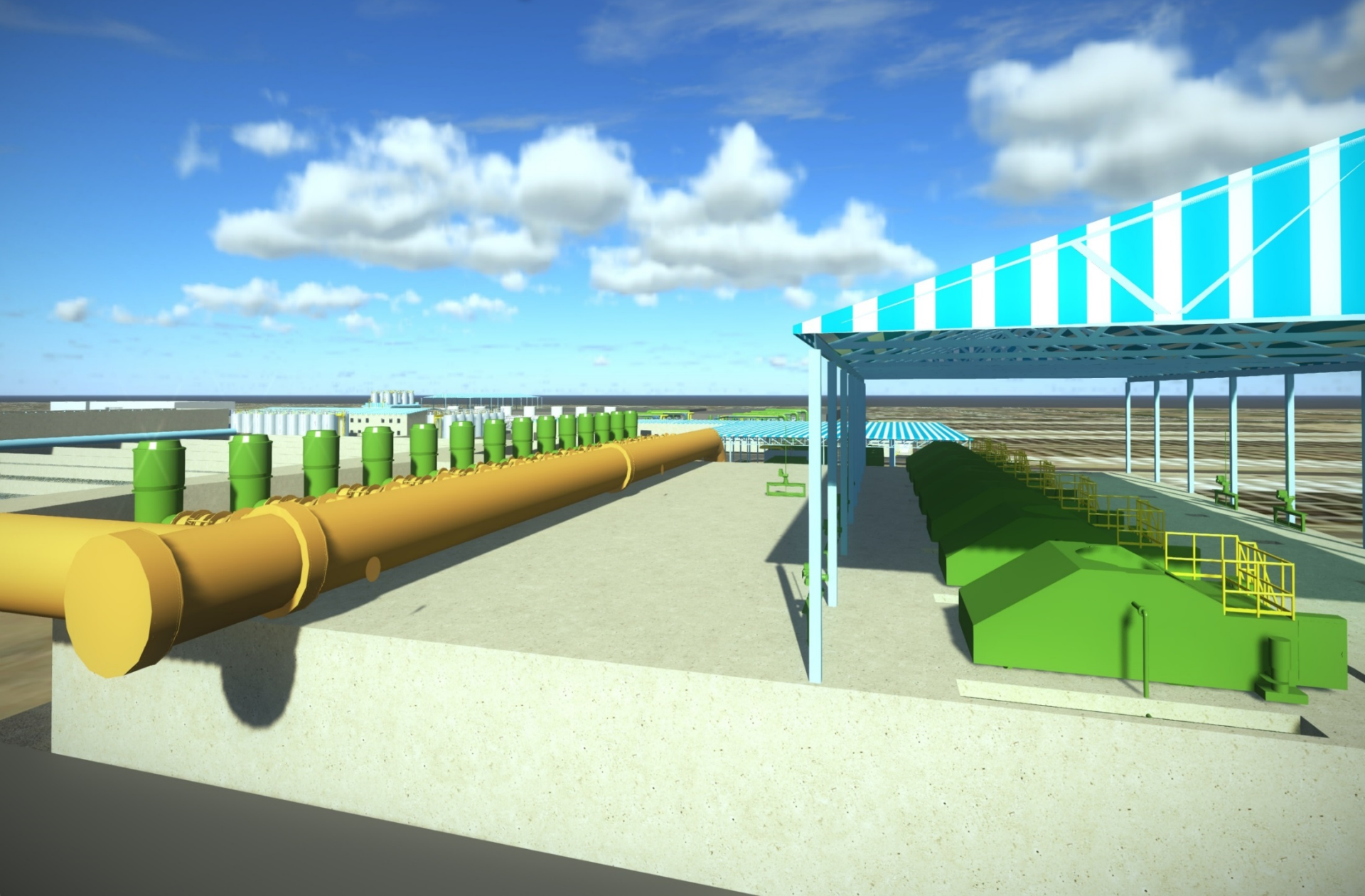

# Aeration Basins

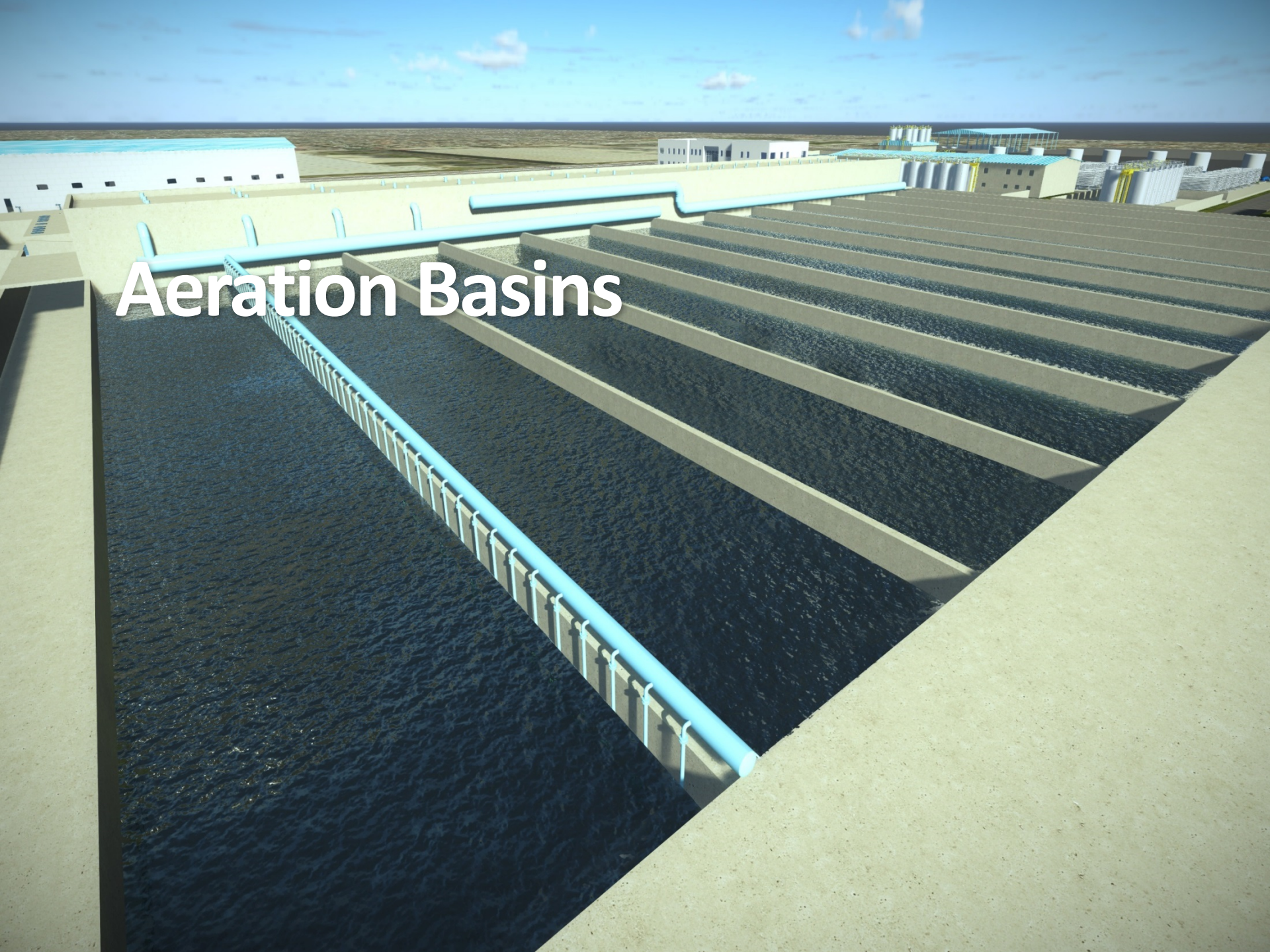

# tMBR Basins

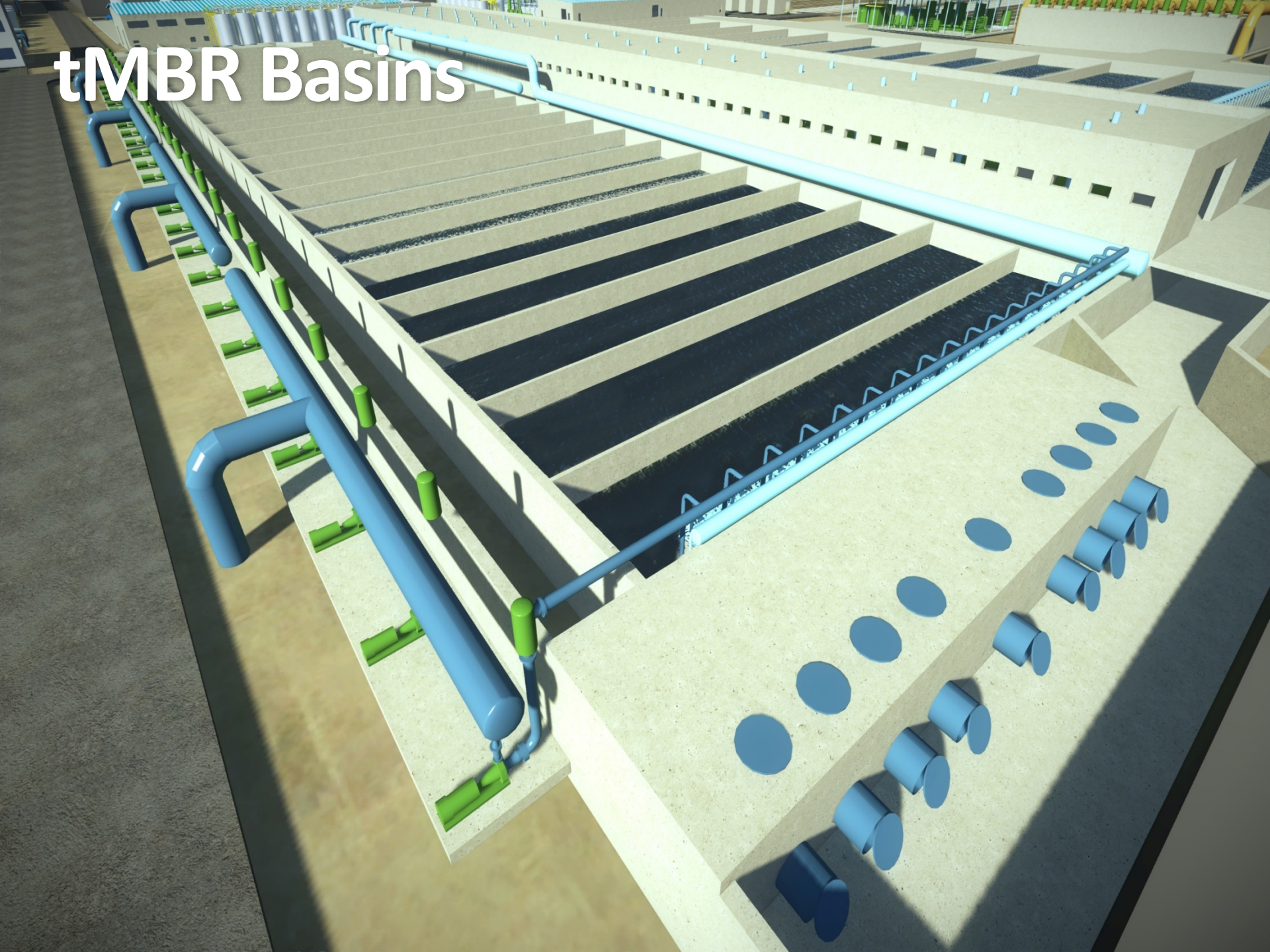

# MicroC2000 Storage

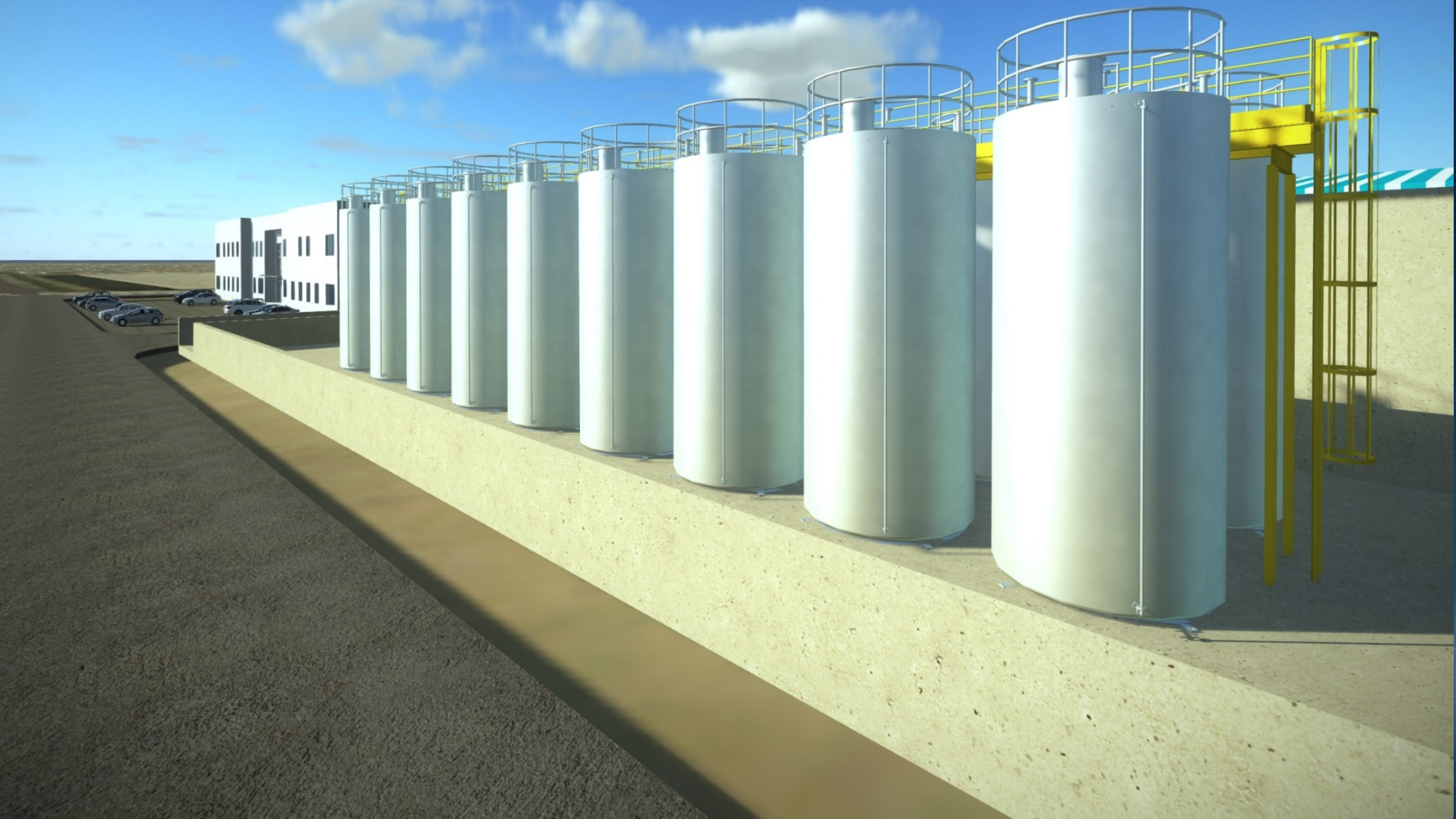



# Membrane Filtration

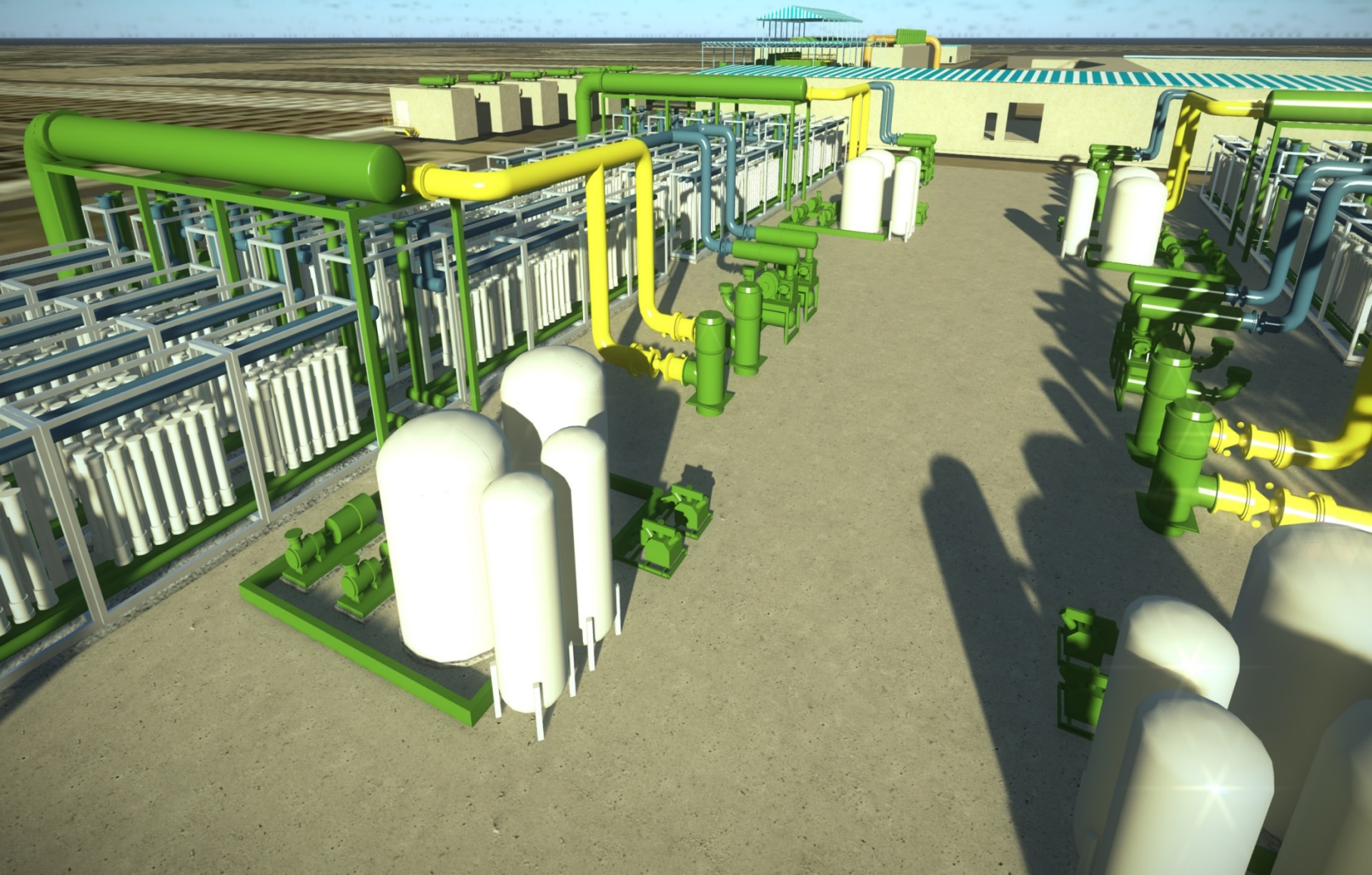

# Cartridge Filters

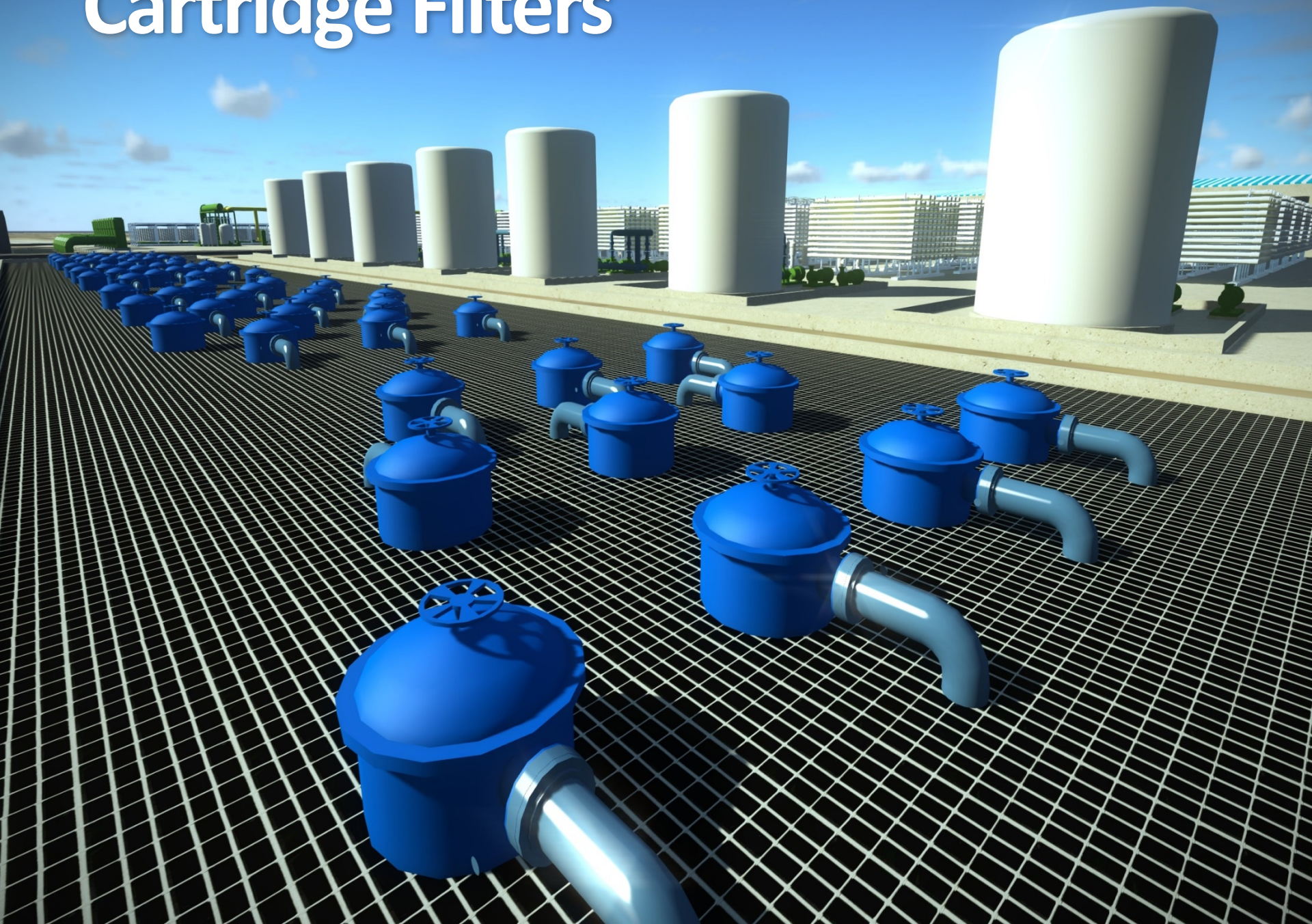

# Bulk Chemical Storage

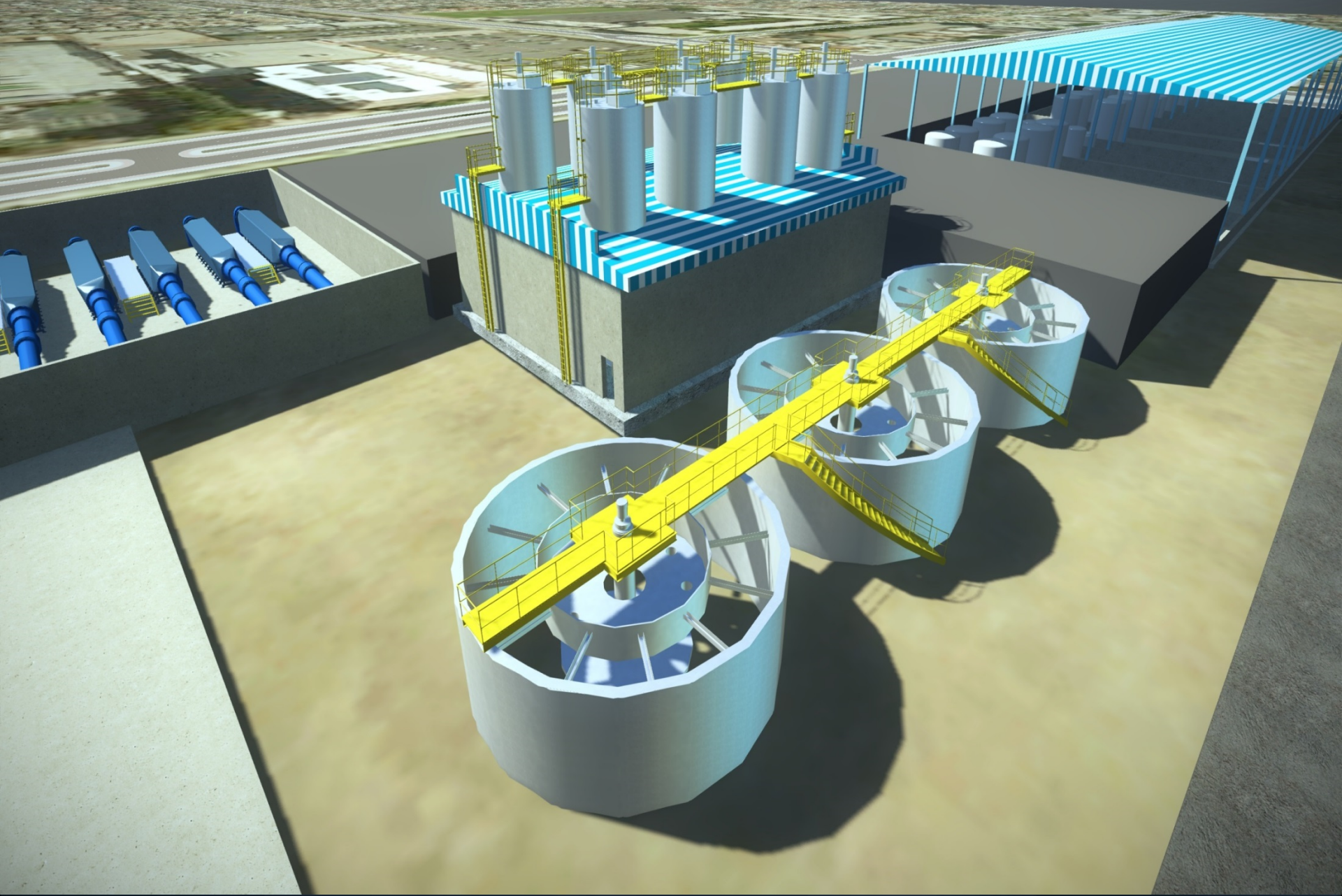

# Reverse Osmosis

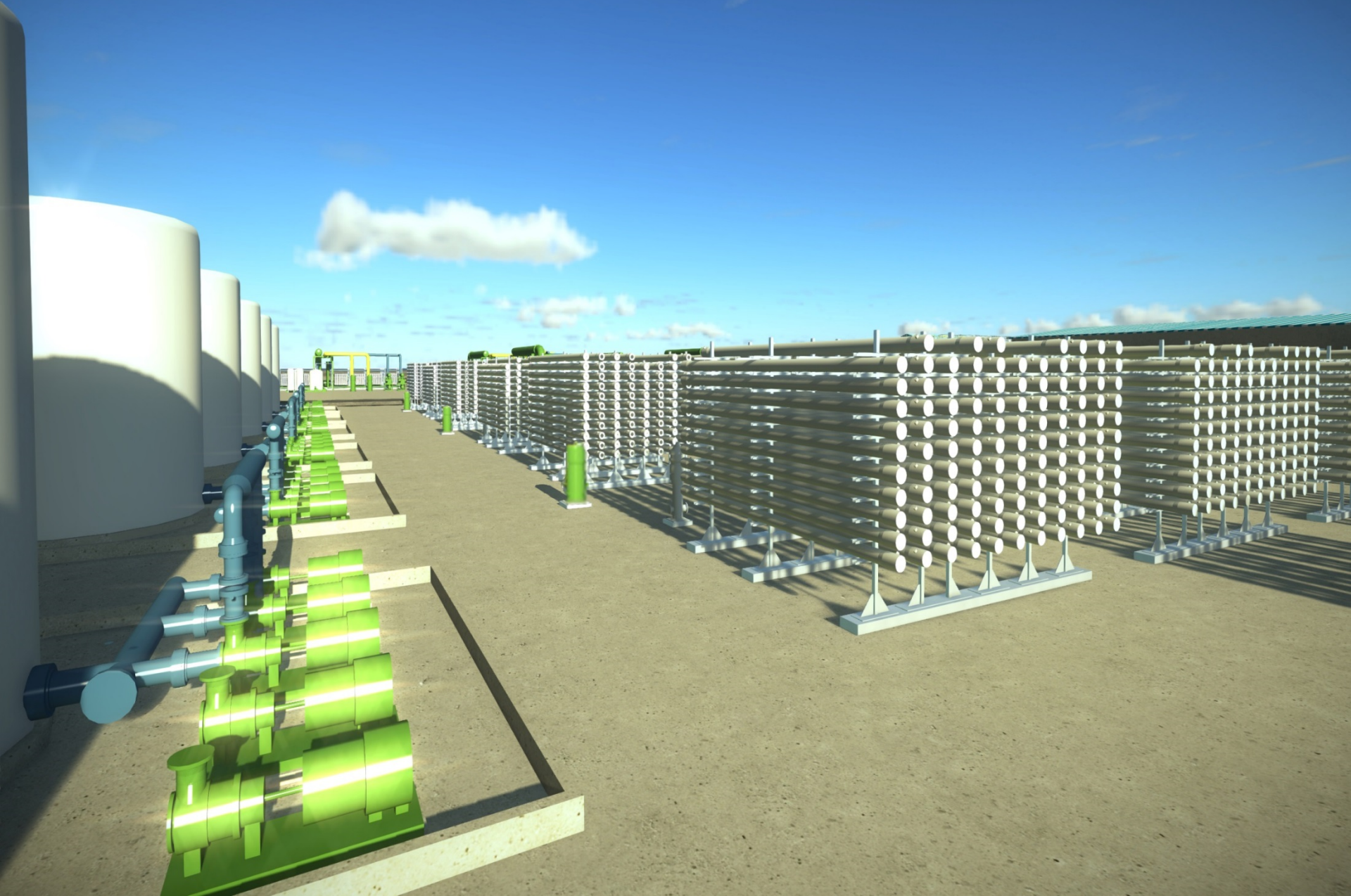

# UV/AOP

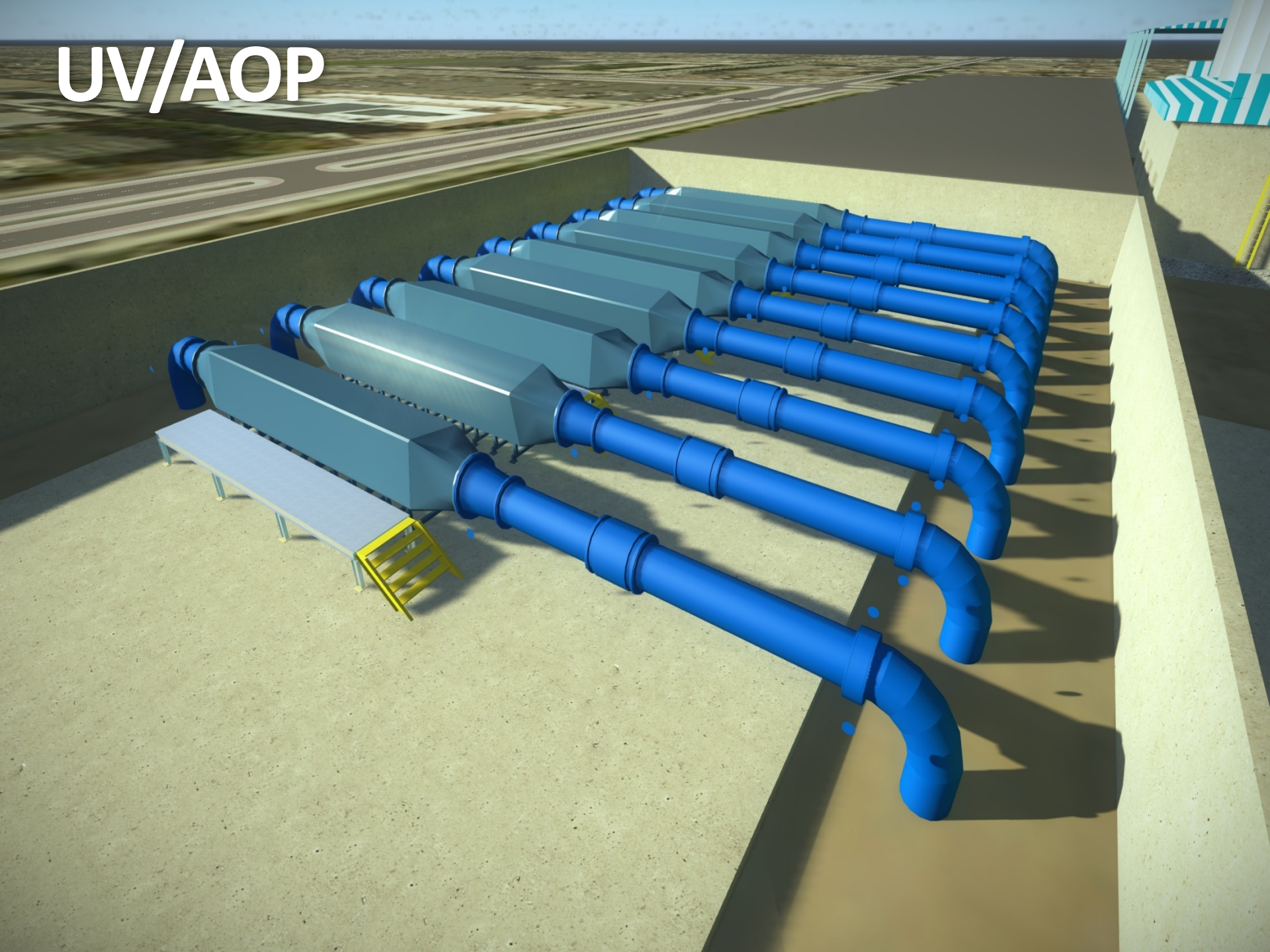

# Post-Stabilization w/ Lime

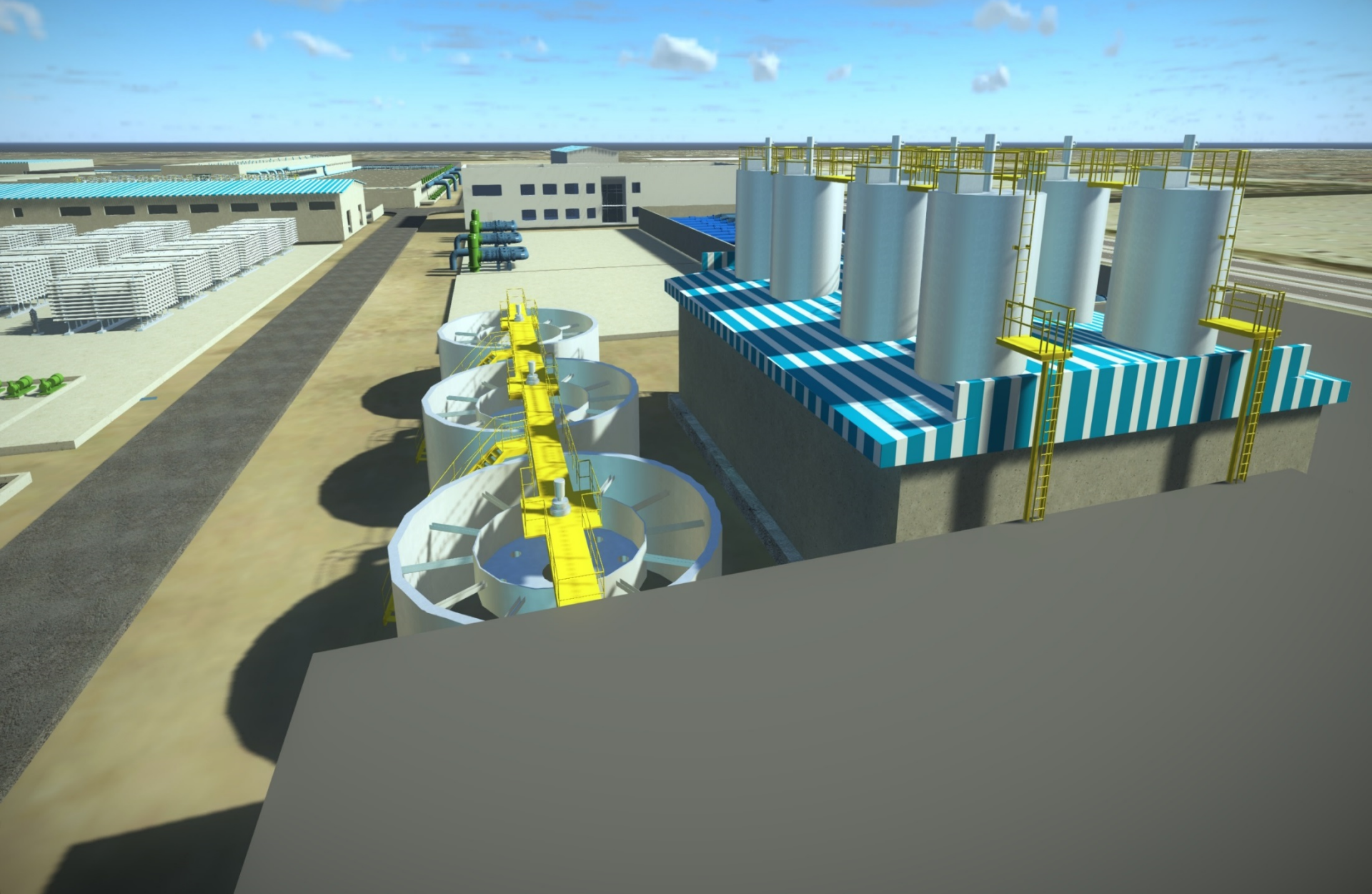



# Conveyance Base Case

Advisory Panel Meeting No. 2  
July 27, 2016

# Conveyance System Overview

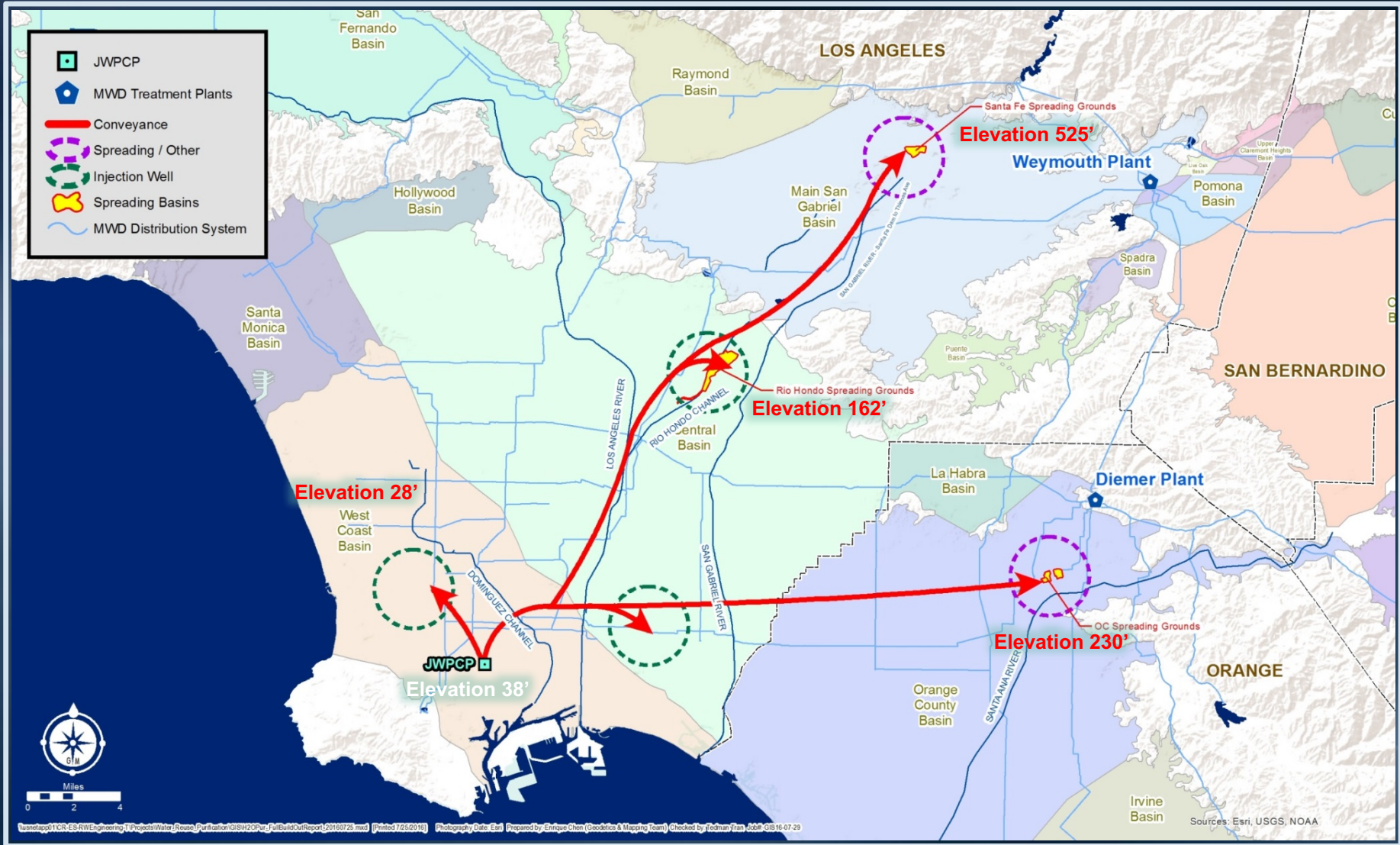



# Conveyance System Scope

Discharge Locations	Type	Groundwater Agency/Operator	Maximum Discharge Volume (MGD)
West Coast Basin, Torrance	Injection Wells	Water Replenishment District of Southern California (WRD)	15
Long Beach	Injection Wells	City of Long Beach/WRD	4
Orange County Spreading Grounds, Anaheim	Recharge Basin	Orange County Water District	60
Central Basin, South Gate	Injection Wells	L.A. County/WRD	10
Rio Hondo Spreading Grounds, Pico Rivera	Recharge Basin	L.A. County Flood Control District	0
Santa Fe Spreading Grounds, Irwindale	Recharge Basin	L.A. County Flood Control District/Main San Gabriel Basin Watermaster	80



# 150 MGD Base Case Schematic

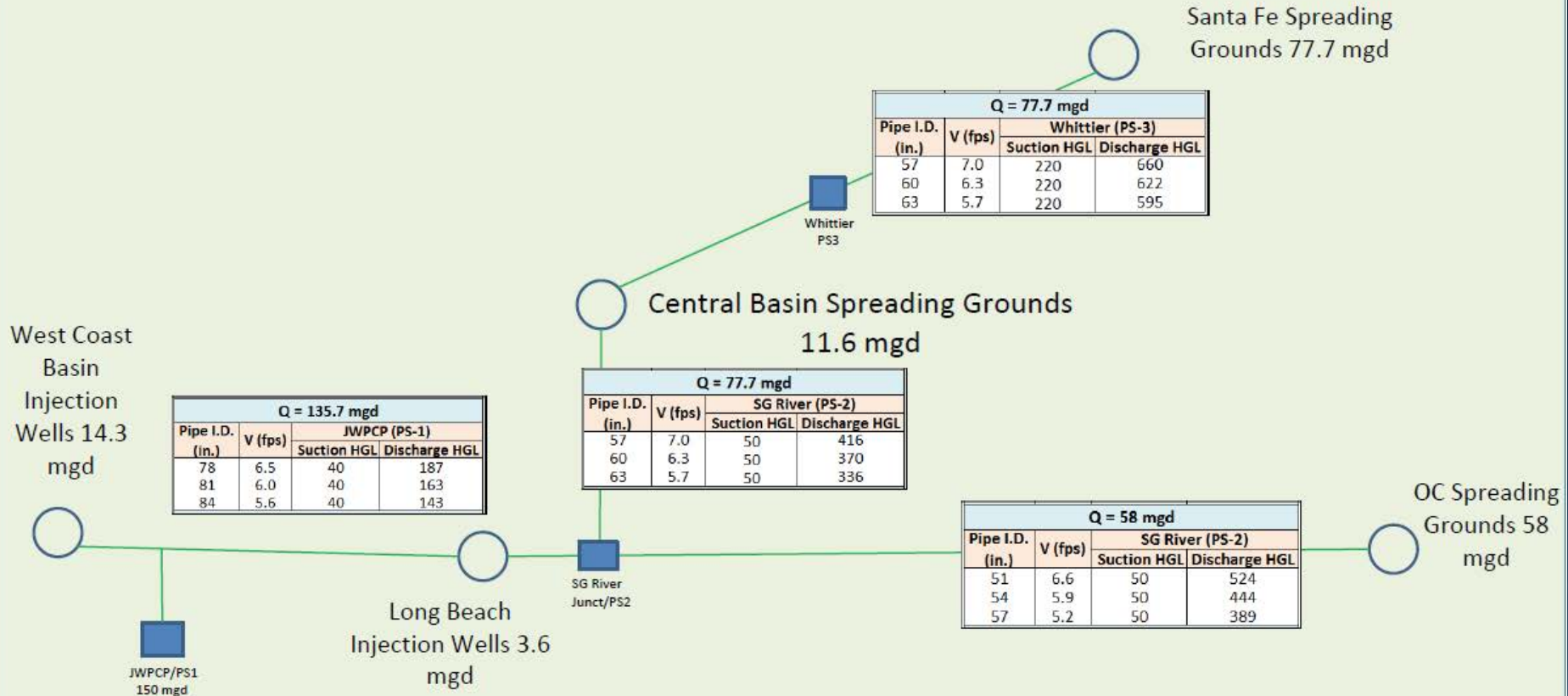

# Alignment Selection Criteria

Constructability

Environmental

Real Property

# Alignment Criteria

- Adequate corridors on public right-of-ways
- Minimal impacts to existing underground utilities
- Geotechnical considerations (active faults, geology, groundwater)
- Traffic control/impacts

# DIAMETER PIPE IN STREET R/W WITH 8' OF COVER

## OPEN CUT

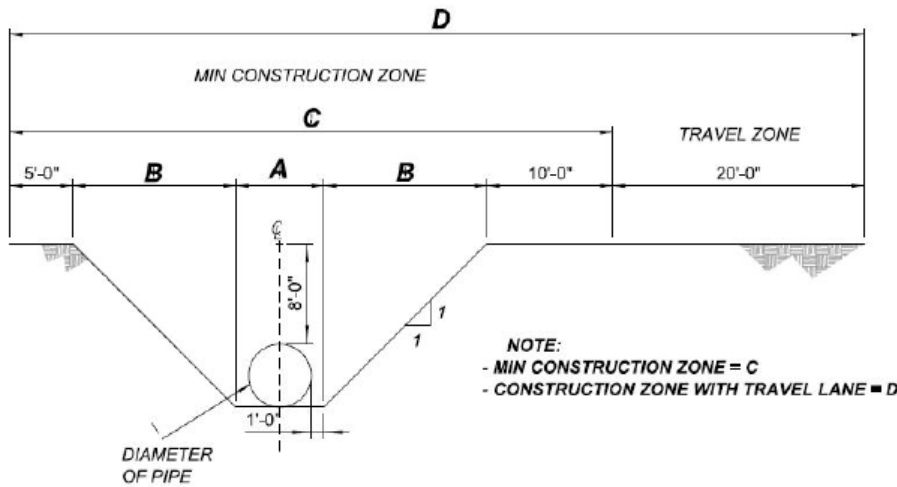

DIAMETER OF PIPE	A	B	C	D
36" (3')	5'	11'	42'	62'
60" (5')	7'	13'	48'	68'
66" (5.5')	7.5'	13.5'	49.5'	69.5'
72" (6')	9'	15'	54'	74'
90" (7.5')	9.5'	15.5'	55.5'	75.5'

# DIAMETER PIPE IN STREET R/W WITH 8' OF COVER

## SHORING

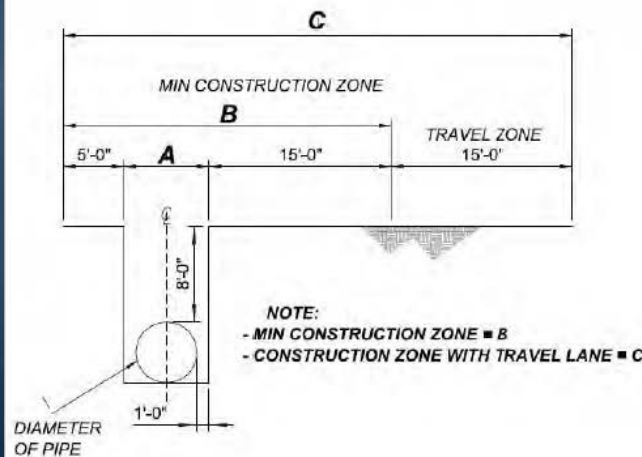

DIAMETER OF PIPE	A	B	C
36" (3')	5'	25'	40'
60" (5')	7'	27'	42'
66" (5.5')	7.5'	27.5'	42.5'
72" (6')	8'	28'	43'
90" (7.5')	9.5'	29.5'	44.5'

# Environmental Considerations

- Minimal impacts to areas with considerations to:

Aesthetics	Agriculture and Forestry Resources
Air Quality and Green House Gasses	Biological Resources
Cultural Resources	Geology & Soils
Hazards & Hazardous Materials	Mineral Resources
Noise	Hydrology & Water Quality
Public Services (Fire Stations, Schools, etc.)	Population & Housing

- Environmental Permitting

- U.S. Army Corps 404 and 408 Permits

# Real Property

- Selection of alignments that have minimal impacts to commercial businesses, industry, and residences
- Selection of alignments that provide properties with multiple access points
- Acquisition of temporary construction easements and permanent easements



# Base Case Alignment



# Tunnel Under Signal Hill

## JWPCP to PS2 using Sepulveda-Willow and Los Coyotes Diagonal

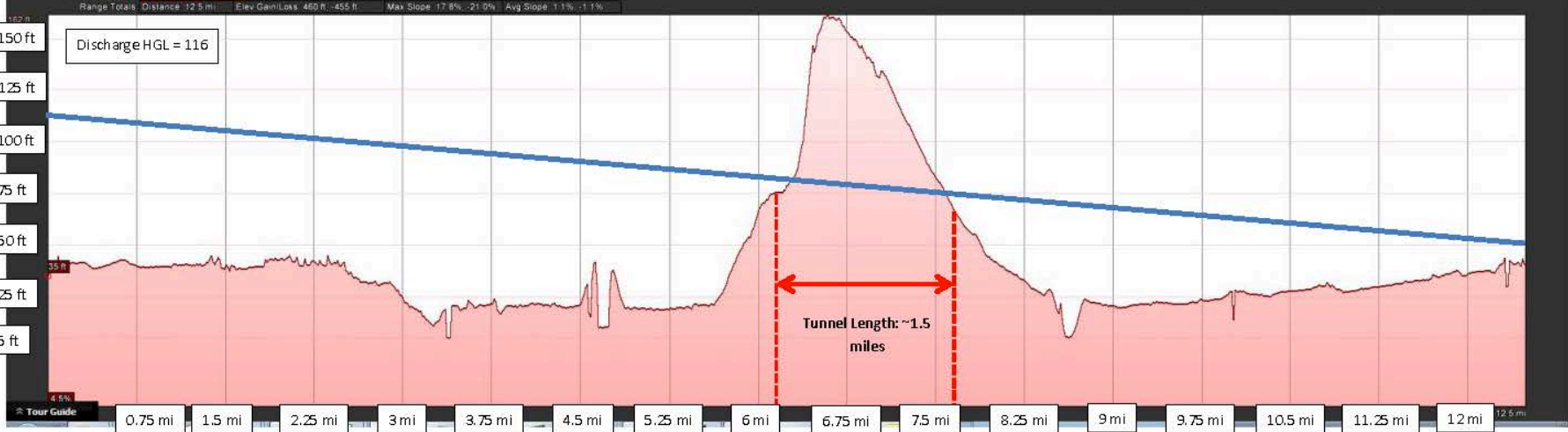
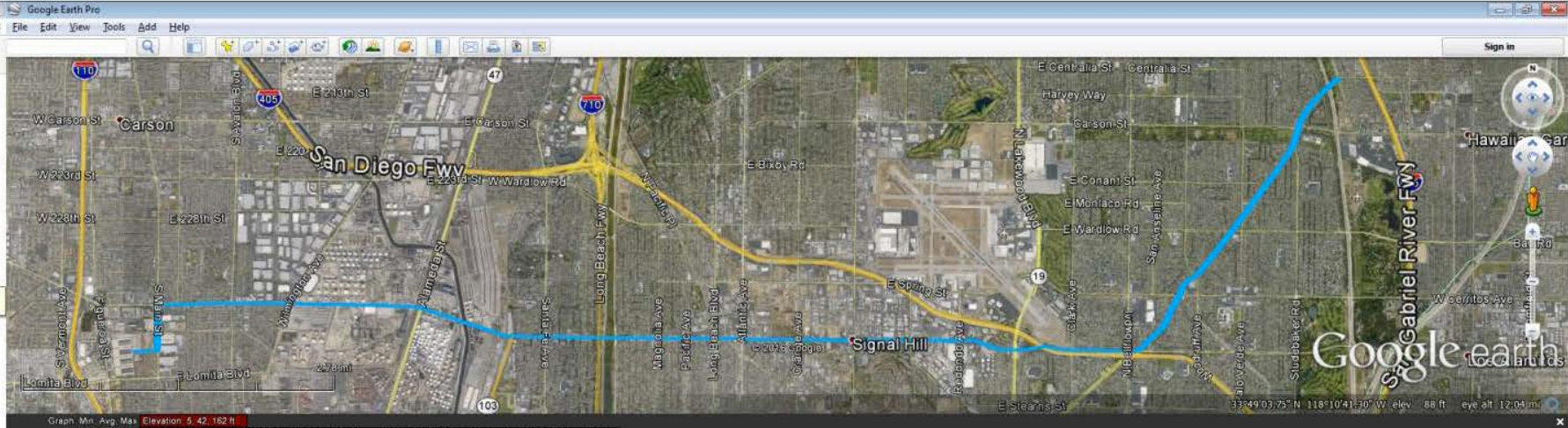

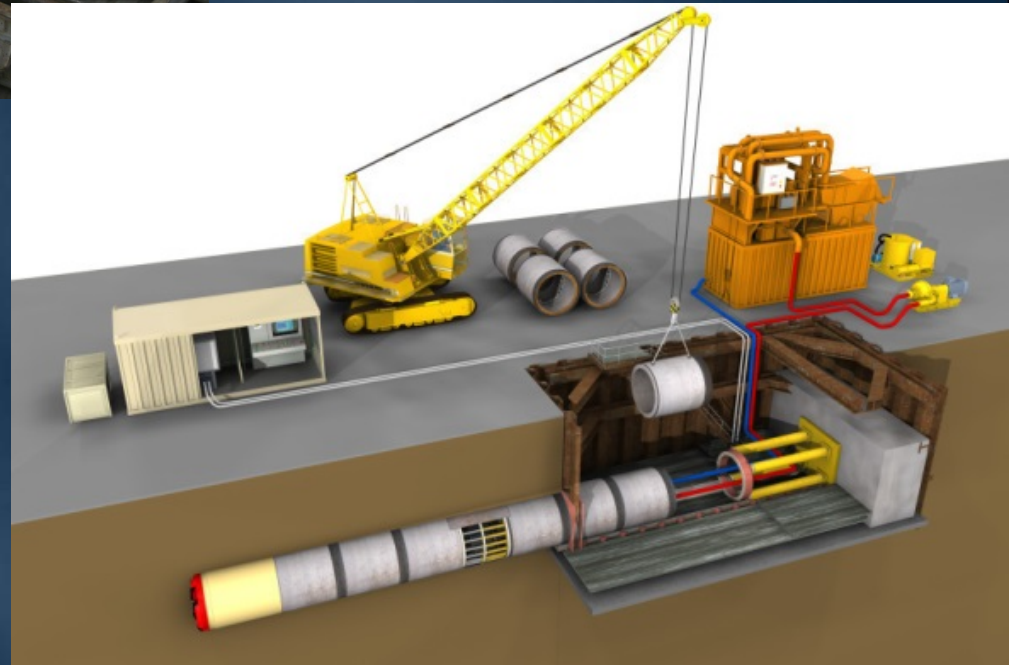

# Base Case Alignment

Reach	Reach Length	Pipeline diameter	Start/End	Right-of-way
1	16 mi	84"	Starts at JWPCP and ends at PS2 adjacent to San Gabriel River in City of Cerritos	Majority of alignment within public street right-of-way with a short stretch along the San Gabriel River
2	16 mi	54"	Starts at PS2 and ends at Orange County Spreading Basins at Anaheim Lakes	Approximately 6 miles of the alignment lies within SCE right-of-way while the remaining 10 miles fall within public street right-of-way
3	14 mi	60"	Starts at PS2 and ends at PS3 near Whittier Narrows Dam	Majority of alignment falls within SCE right-of-way paralleling the SGR
4	10 mi	60"	Starts at PS3 and ends at the Santa Fe Spreading Grounds in	A majority of the alignment falls within SCE and Los Angeles County Flood Control District right-of-way with a portion falling within public street right-of-way

# Base Case Alignment - Pumps

Pump Station	General Location	Pumps To
PS1	JWPCP, Carson	150 MGD to PS2 15 MGD to West Coast Basin
PS2	Adjacent to San Gabriel River near Carson Street	60 MGD to Orange County Spreading Grounds 80 MGD to PS3
PS3	Near Whittier Narrows, Pico Rivera	80 MGD to Santa Fe Spreading Grounds

# Summary of Base Case Description

- 54 miles of pipeline conveying 150 MGD
- Pipe diameters ranging from 54" to 80"
- 3 pump stations delivering water in West Coast Basin, Orange County Basin, Central Basin, and Main San Gabriel Basin



# Update on Groundwater Basins for Advisory Panel

Advisory Panel Meeting No. 2  
July 27, 2016

# General Approach

## Demand Analysis

Is there sufficient demand for project water?

## Operational Assessment

Are there operational issues that may limit how much can be recharged?

## Groundwater Modeling

What are the impacts of recharge and extraction of project water?

## Facility Needs

Are additional facilities required?



# Agency Coordination

## Member Agencies

- Staff met with member agencies to review demand analysis

## Basin Managers

- Staff had several meetings with Main San Gabriel Watermaster, WRD, and OCWD to review program and develop groundwater modeling assumptions

## LACDPW

- Staff met with LACDPW staff on multiple occasions (including a field trip) to discuss operational requirements

# Summary of Discussions

- Reaction to project has generally been positive
- Each basin received technical presentation of assumptions for their basin – these assumptions were updated based upon feedback received
- Groundwater modeling assumptions for each basin were developed over a series of meetings between the basin managers and Metropolitan

# Demand Analysis

## General Methodology

- Identified range of project water demand
  - Replenishment Demand (IRPSIM)
  - MWD Consumptive Demand (IRPSIM)
  - 80% of minimum month refineries demand
- Estimated existing GW pumping capability
  - Quantity of groundwater that could be pumped with existing well capacity and facilities
- Evaluated existing spreading basin capacity
  - Existing spreading grounds and other flood control facilities
- Determined the sustained delivered capacity available for project water

# Operational Assessment

## General Methodology

- Spreading Capacity
  - Threshold for feasibility = available > 95% of the time
  - Time for cleaning of basins included in analysis
- Diluent Water
  - Assume 3 year ramp-up from 50-75-100% (Orange County – 75-100%)
  - Threshold for feasibility = available > 95% of the time

# Groundwater Modeling

## Assumptions

- A wet period was used for the groundwater modeling to estimate worst case recharge conditions – different for each basin
- Increased production was assumed to be accomplished with existing wells. Staff from Metropolitan and each Basin Manager worked together to identify which wells would increase production
- The goal was to maximize use of existing facilities – new facilities were sited by the Basin Managers with input from Metropolitan staff

# Status: Groundwater Modeling

## Central Basin/West Coast

- Executed contract with WRD
- Discussed initial runs with WRD + CH2M staff
- Completed initial run of proposed project
- Awaiting particle tracking data

## Main San Gabriel

- Execution of contract with MSG
- Discussed initial runs with MSG Watermaster + Stetson staff
- Expect results in next few days

## Orange County

- Completed baseline run
- Completed initial run of proposed project

# Base Case Normal (150 MGD)

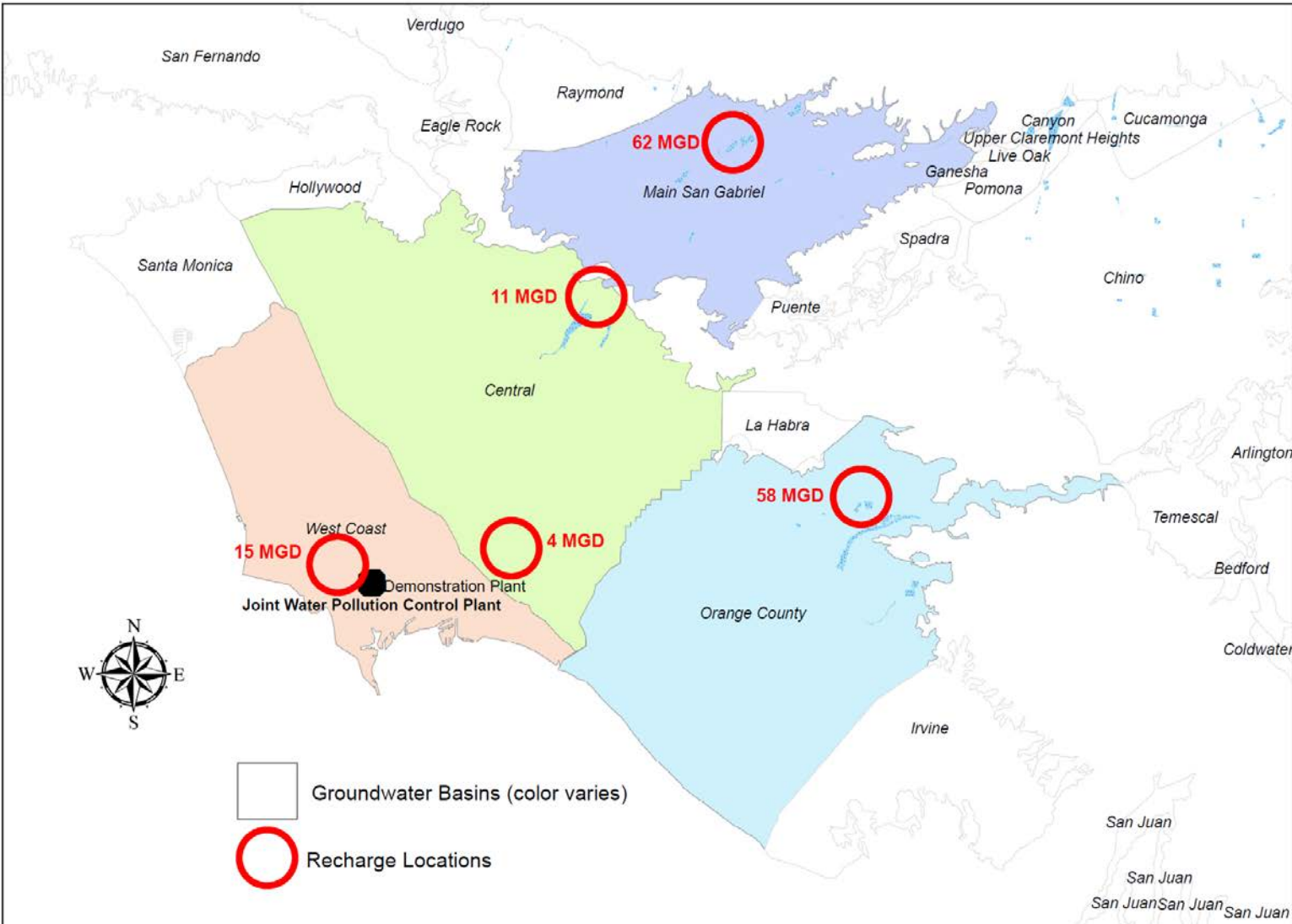

Base Case - Normal Operation

# Base Case Wet Period (110MGD)

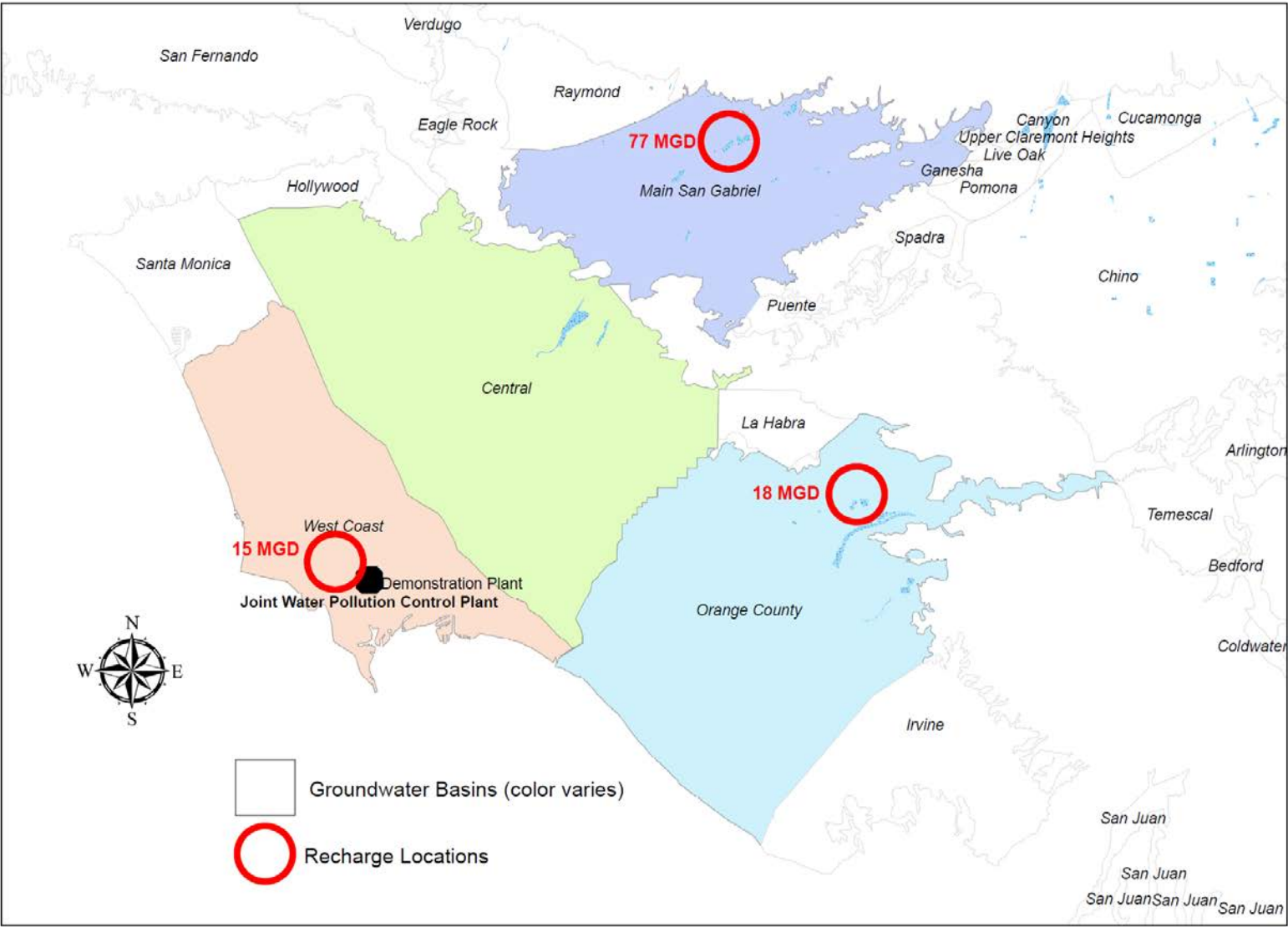

Base Case - Wet Period Operation



# Base Case (110-150 MGD)

Groundwater Basin	Member Agency	Recharge Location	Amount 85% of the time (TAFY)	Amount 15% of the time (TAFY)	Amount for Pipeline Size (MGD)	Notes
Central Basin	Central Basin MWD	Montebello Forebay	3.0	0.0	11.6	Delivered at WN Dam
	Los Angeles	Montebello Forebay	10.0			Alternatives to base case: 10-15 acres of new spreading basins/injection wells
	Long Beach	Existing Injection Wells	4.0	0.0	3.6	Existing injection wells
Main San Gabriel	Upper District & Three Valleys	Santa Fe	70.0	85.0	77.7	Upsized to handle MSG+CB recharge
Orange	MWDOC	GWRS Basins	65.0	20.0	58.0	Using all OCWD recharge basins
West Coast Basin	Torrance & West Basin	New Injection Wells	11.0	11.0	9.8	Will require 10-15 new injection wells
	Los Angeles	Refineries	5.0	5.0	4.5	Alternative to base case: additional injection wells
Total			168.0	121.0	150.0	

# Detailed Basin Analysis

# Main San Gabriel Basin

# Project Water Demand in MSG

## 50-85 TAFY of Potential Project Water Demands

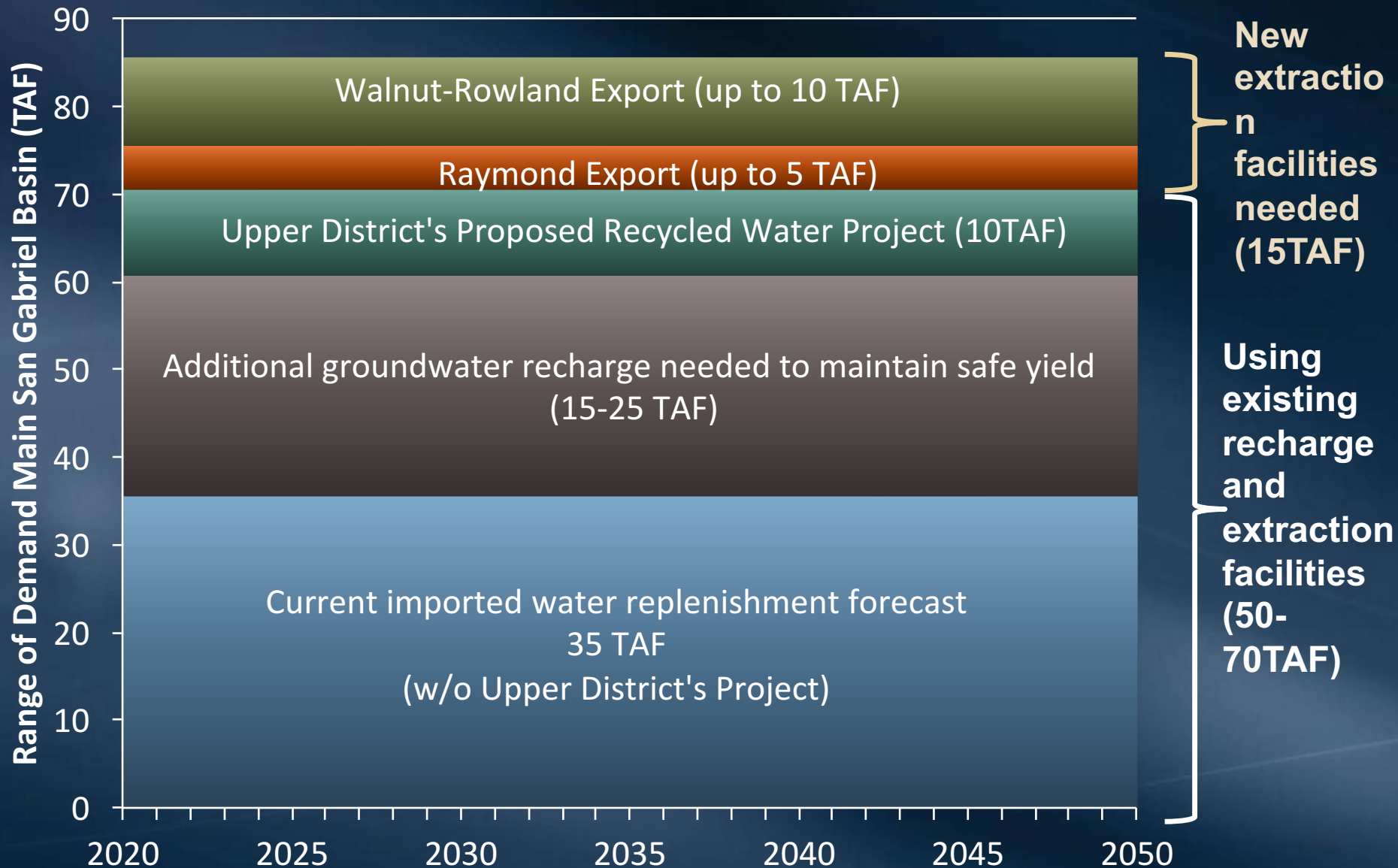

# Adequate Spreading Capacity in MSG

Available 94% of the time at Santa Fe SG

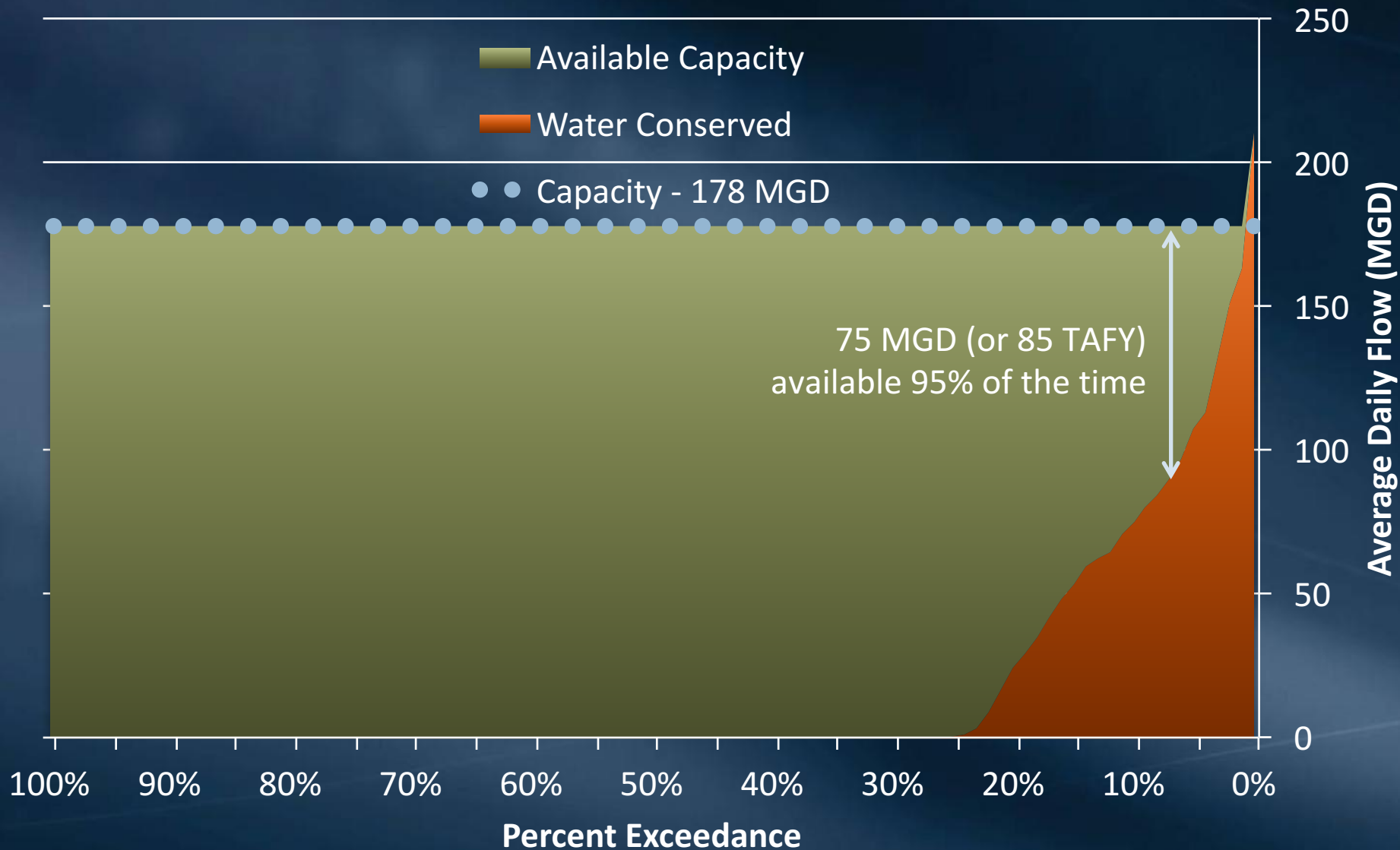

# MSG Diluent Water (above SFSG)

With Upper District Project, insufficient diluent water for MWD project - limited to 35 TAFY to 65 TAFY.

Without Upper project, 70 TAFY available 100% of the time.

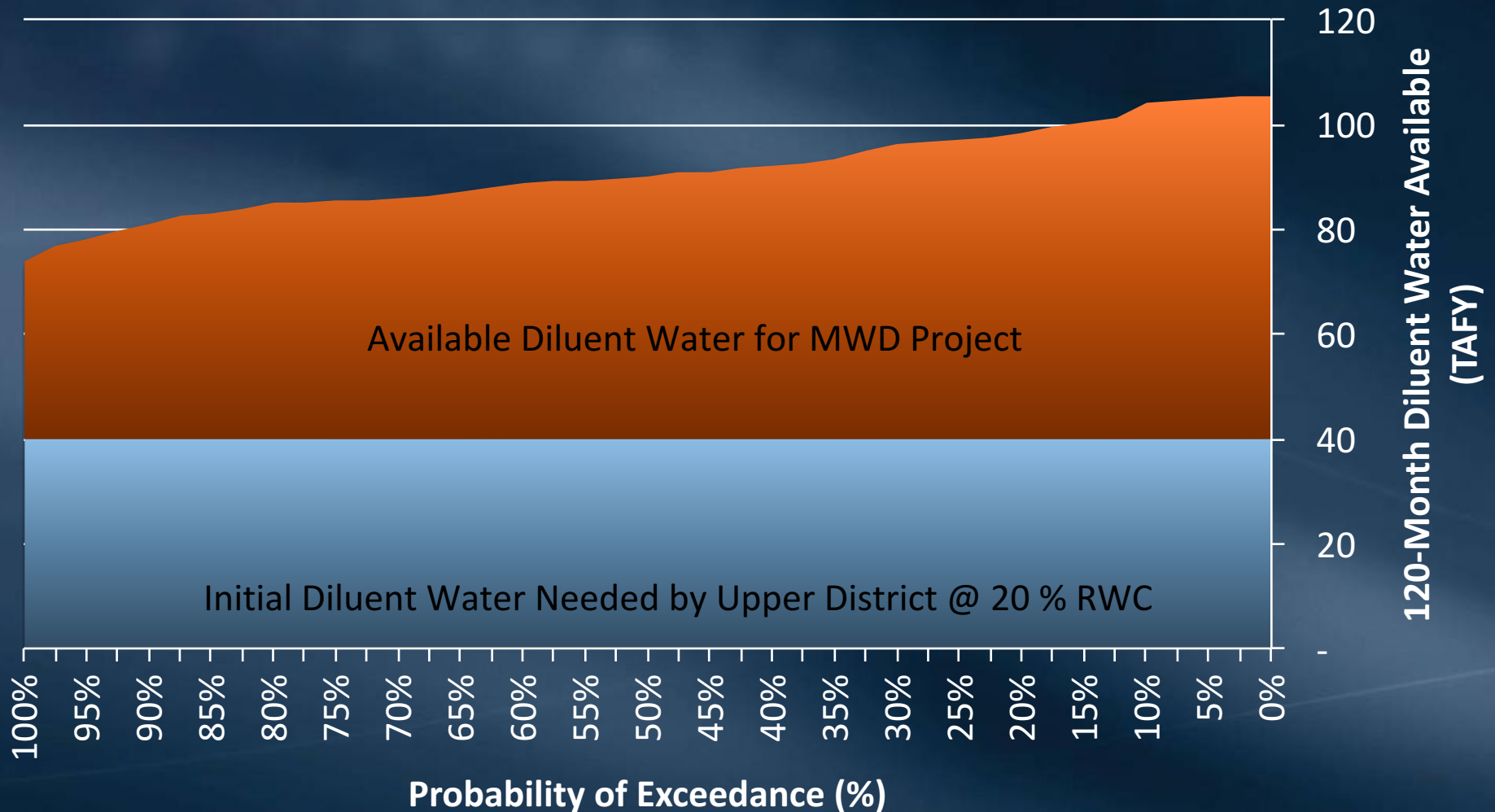

# MSG Preliminary Modeling Results

- Overall, the modeling results are favorable.
- At 62 MGD, key well elevation as high as 320 feet above MSL during wet periods
- During wet periods, there is mounding below Sante Fe Spreading Grounds – diverting water to other spreading grounds can alleviate the mounding concerns
- Increasing to 77 MGD during wet periods may require increased production and/or export

# Orange County Basin



# Orange County Groundwater Basin

- Adequate Demand for Project Water
  - Imported Demand = 160-250 TAFY
  - Current replenishment Demand = 65 TAFY
- Sufficient Well Capacity to Pump Water
  - Existing Capacity = 420-440 TAFY
- Limited by Available Spreading Capacity
  - Winter = 18 MGD
  - Summer = 60 MGD
  - Would need additional 30-60 Ac. spreading capacity (just to spread current replenishment demand)

# Project Water Demand in Orange

## 65-95 TAFY of Potential Project Water Demands

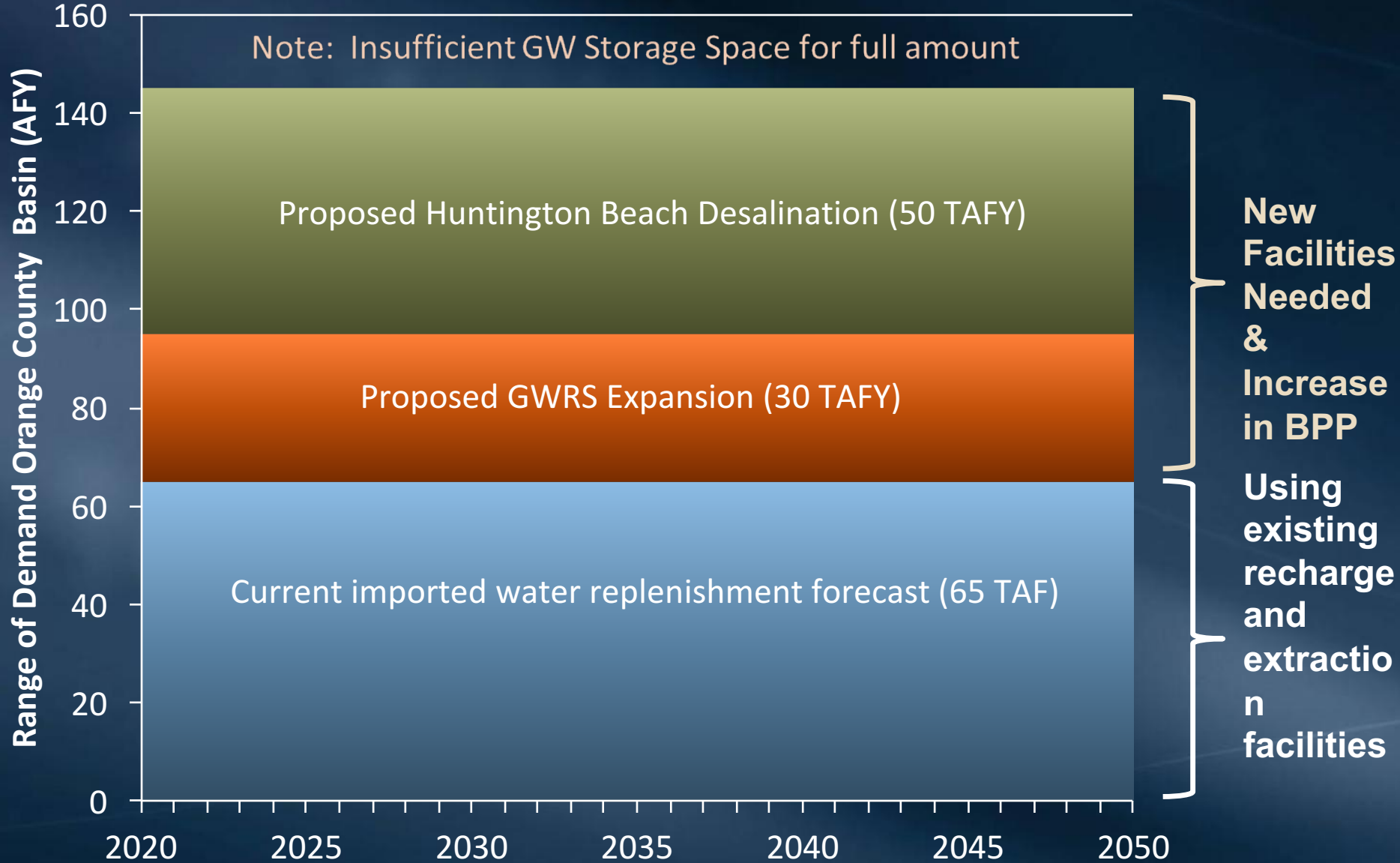

# GWRS Dedicated Basins Only

Insufficient capacity for project

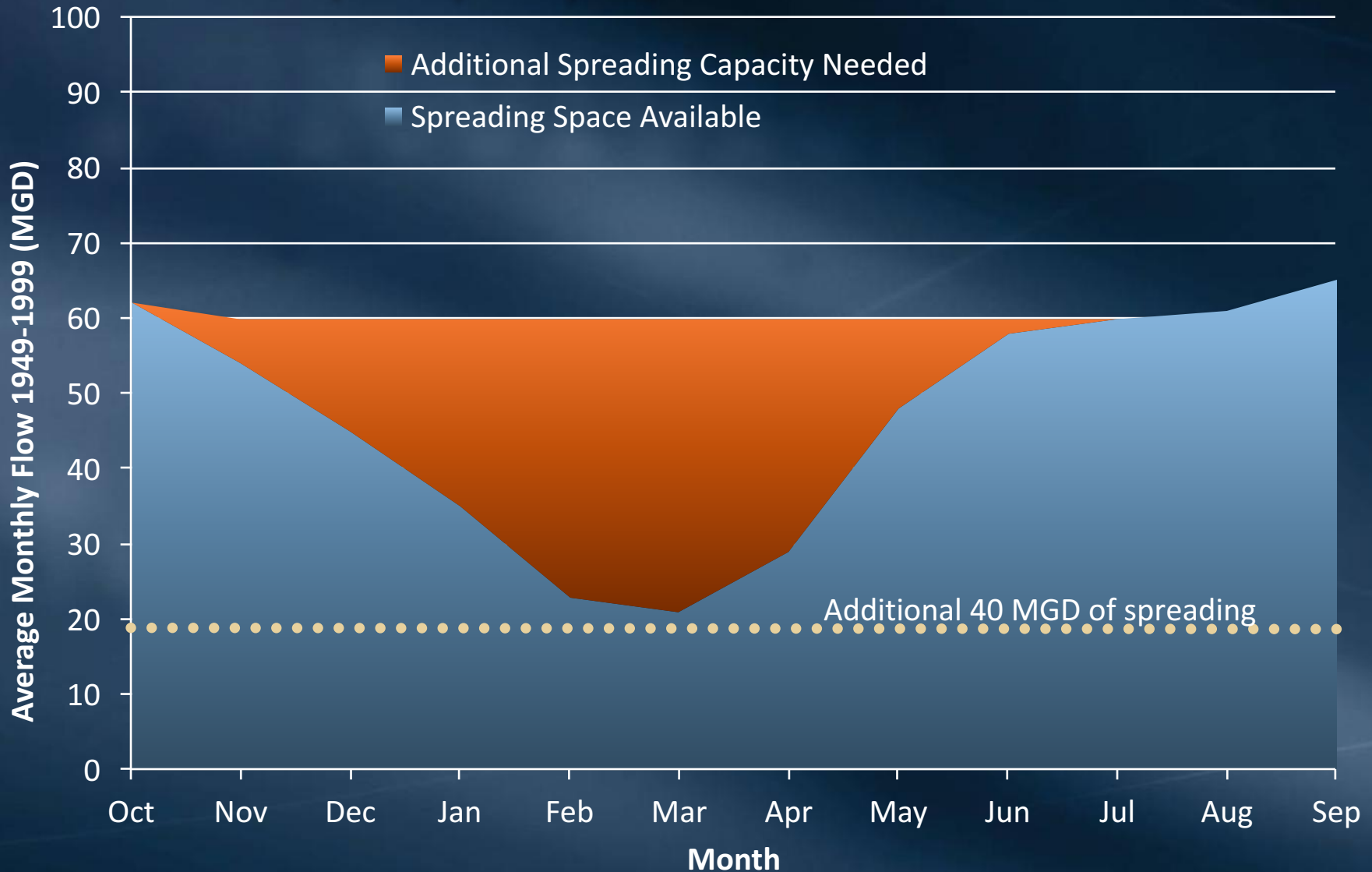

# Limited Available in All OC Basins

Only available 85% of the months

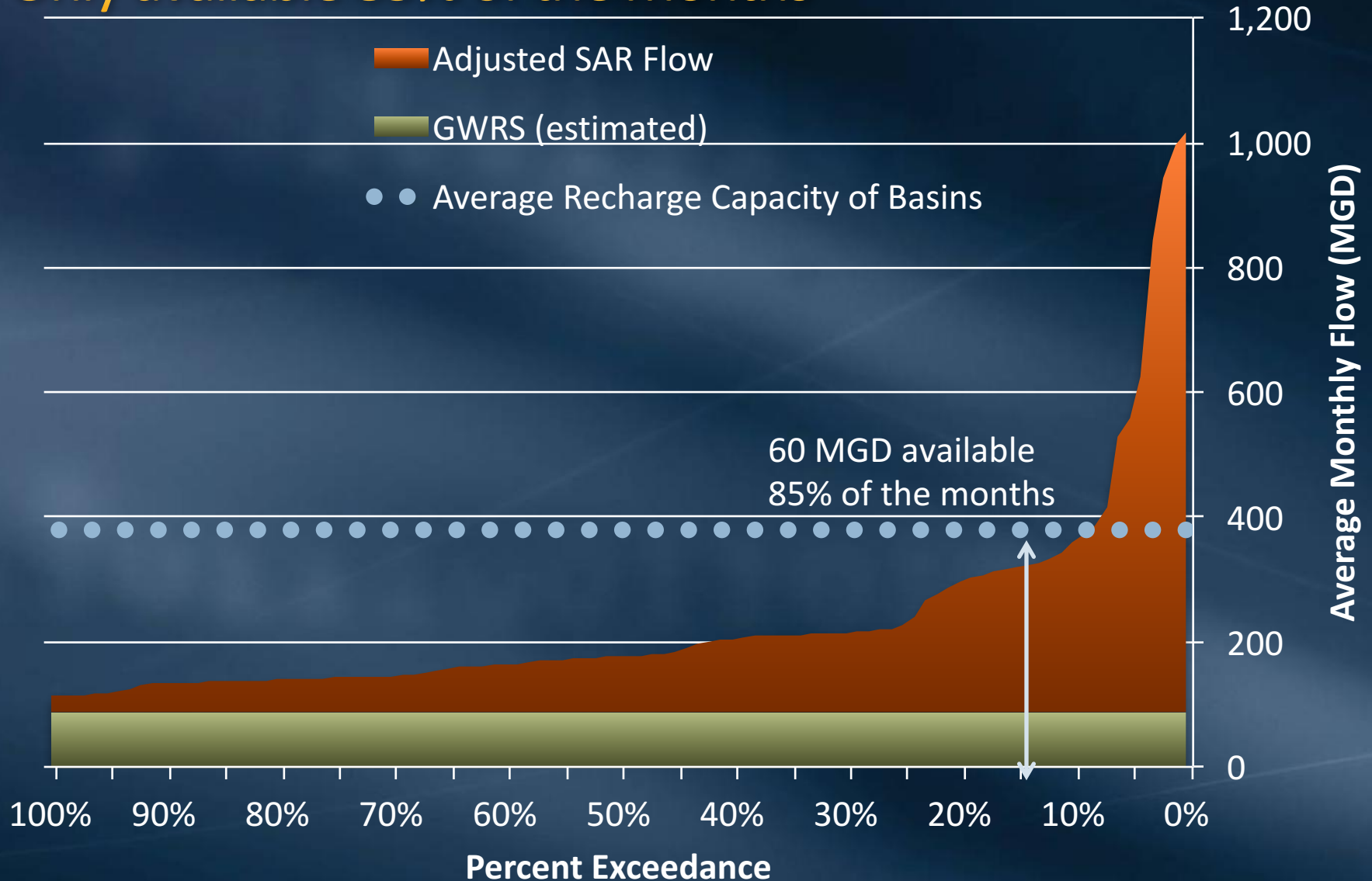

# Orange County

Sufficient Diluent Water Avail. 100% of the time

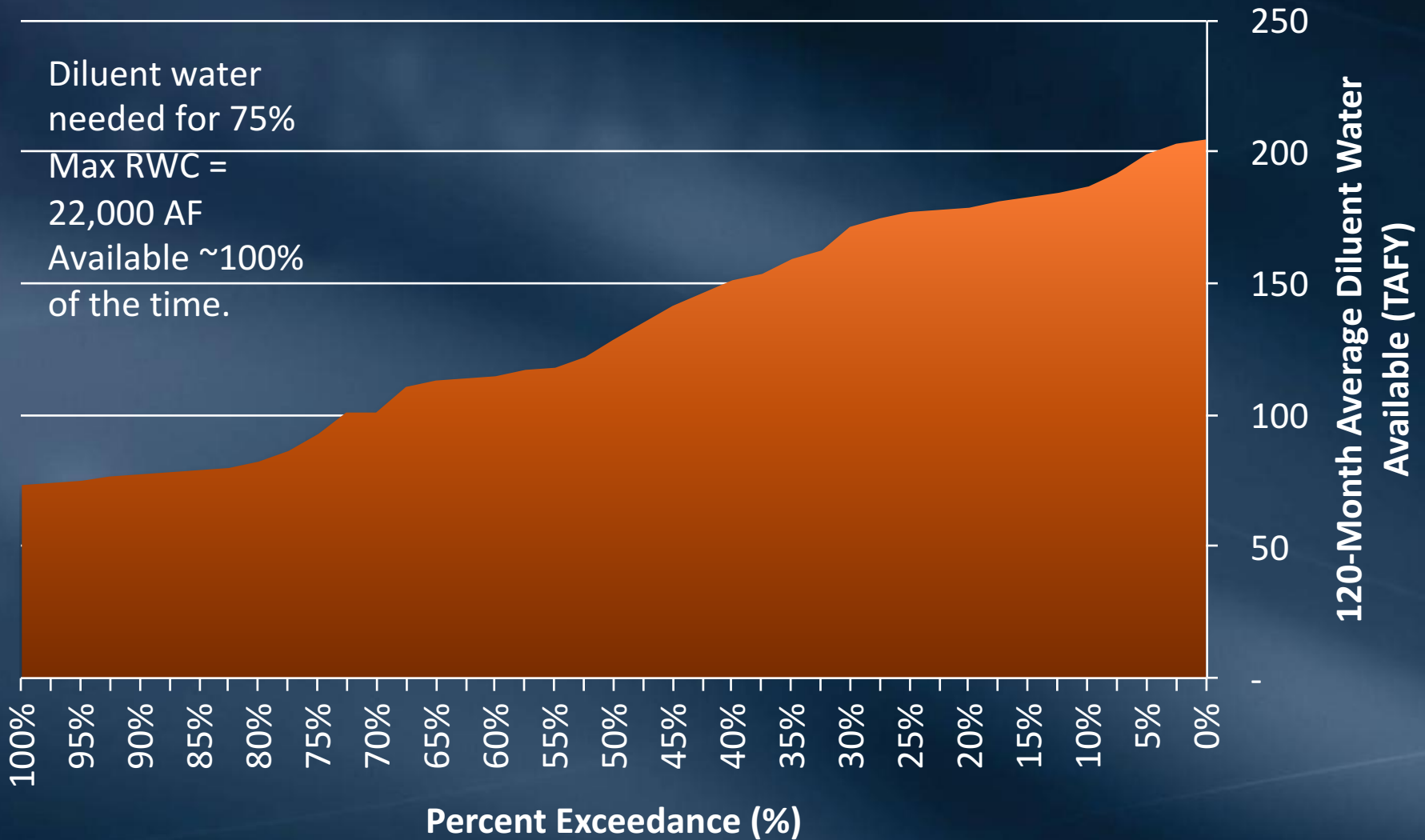

# Preliminary Modeling Results

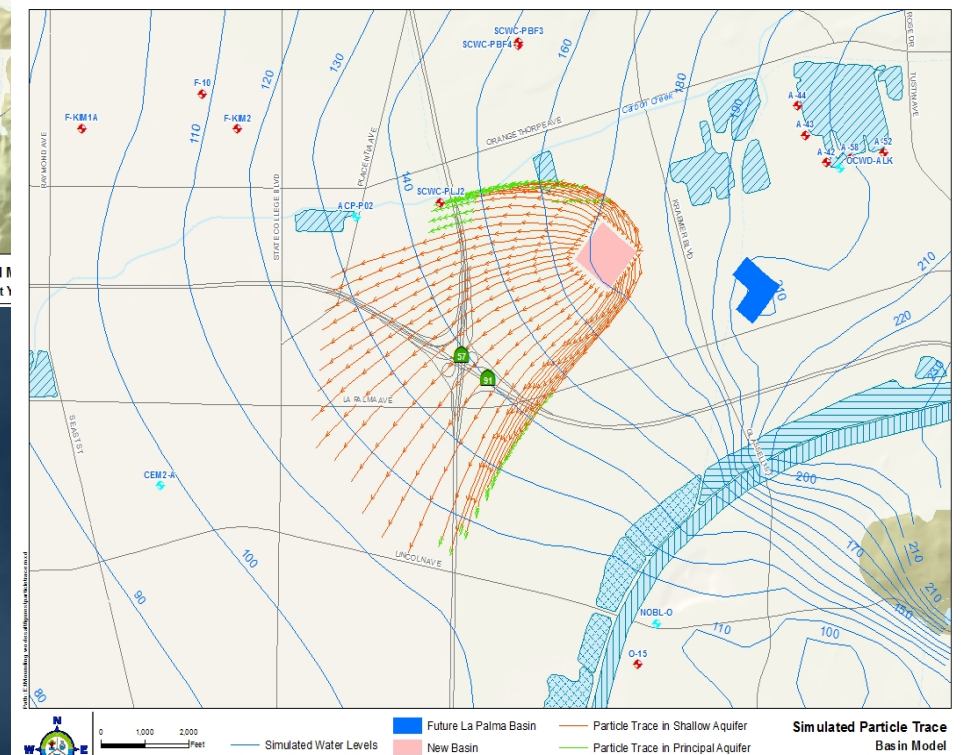
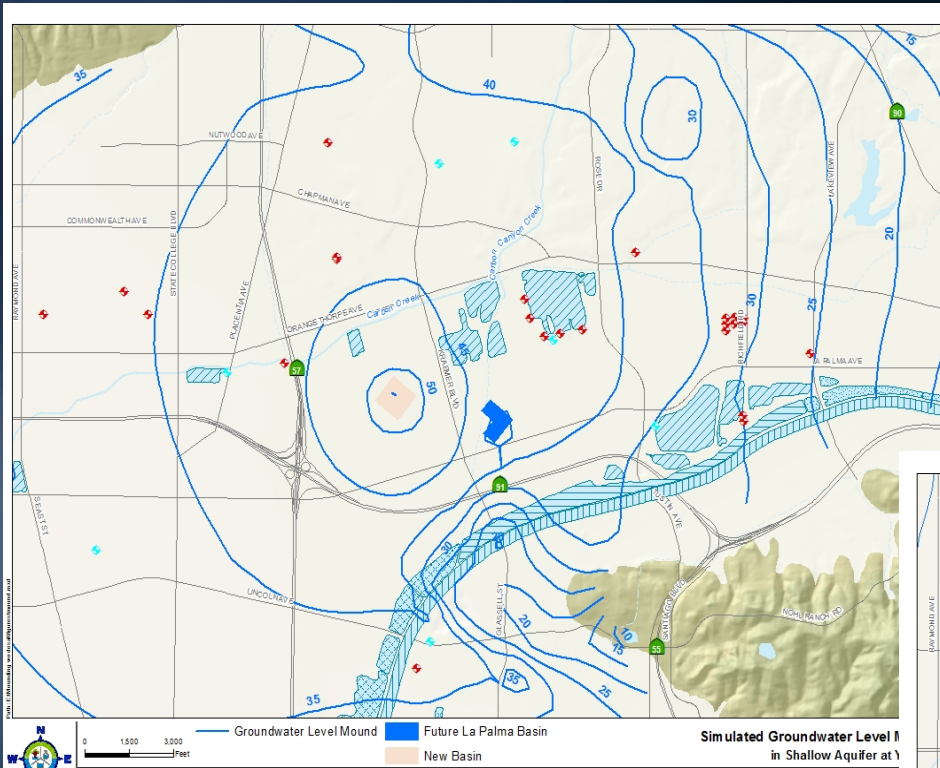

# Central Basin

# Central Basin Assessment

## ● Demand

- Excluding GRIP Project
- Imported Demand = 40-80 TAFY
  - Potential = 16-26 TAFY
- Current replenishment demand = 14 TAFY

## ● Well Capacity

- Existing Capacity = 200 cfs for 7 agencies

## ● Available Spreading Capacity

- 550 cfs – water lost 27% of the time
- May need injection wells for LA Forebay/Central Basin recharge – may require as many of 30



# Project Water Demand in Central

## 4-47 TAFY of Potential Project Water Demands



# Groundwater Pumping Capability

## Ability to pump additional 16-32 TAFY

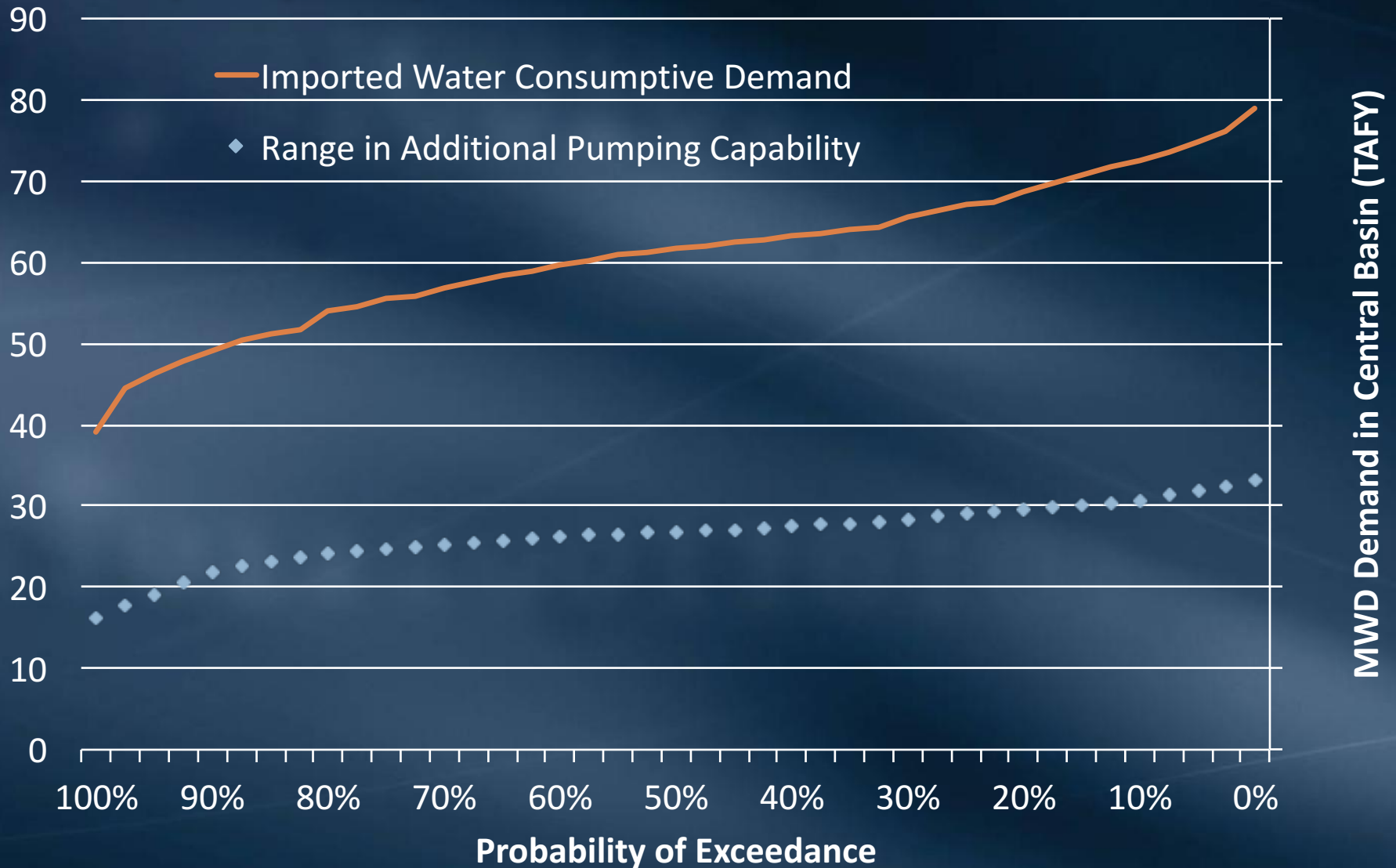

# Available Capacity (Rio Hondo)

Space available 96% of the time

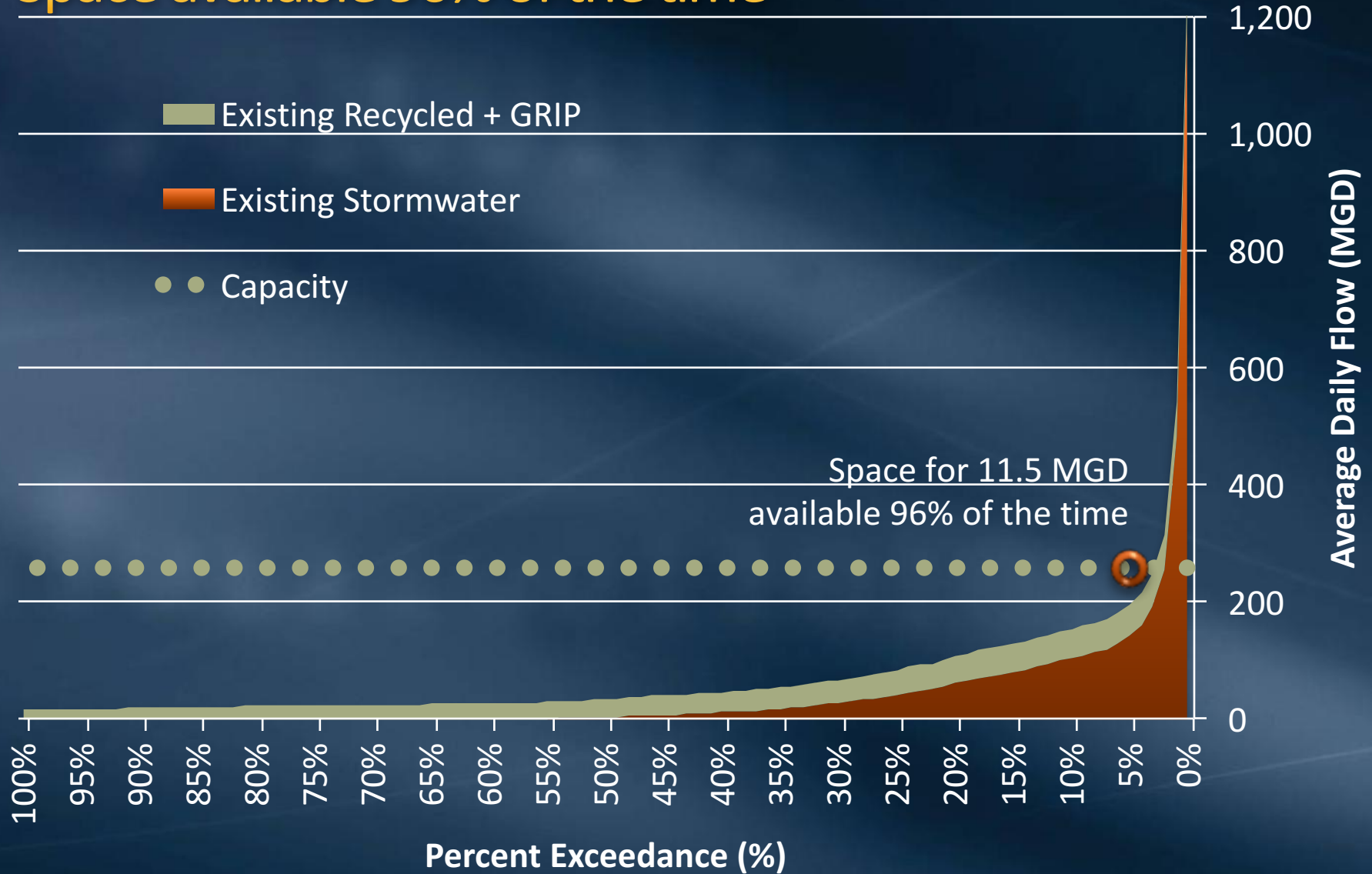

# Central Basin Montebello Forebay

Sufficient Diluent Water avail. 50-85% of the time

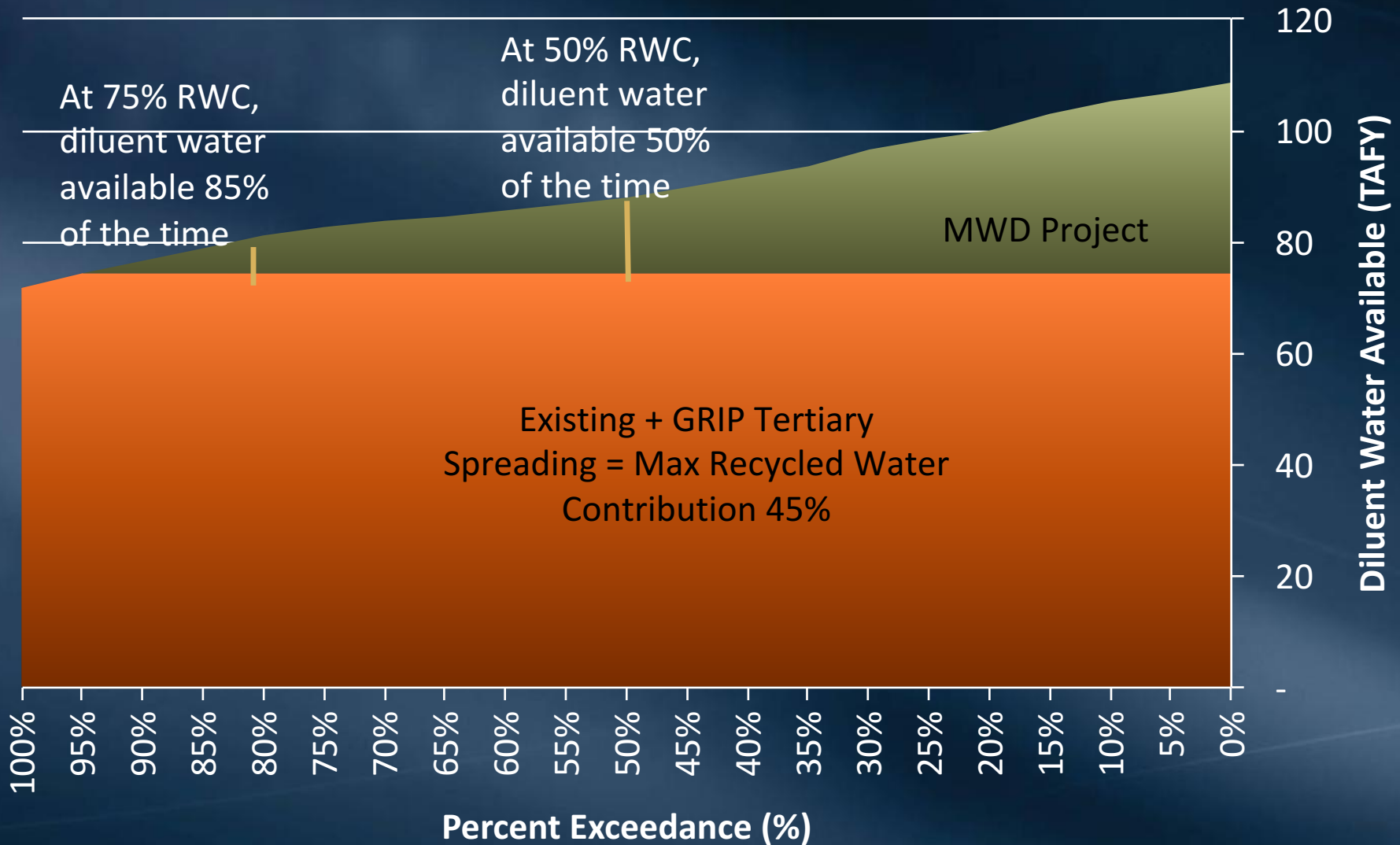

# West Coast Basin

# West Coast Assessment

- Demand

- Imported Demand = 100-130 TAFY
- Replenishment Demand = 0 TAFY
- Refineries – 5 TAFY

- Well Capacity

- Existing Capacity (6 agencies) = 75-80 cfs
- Additional Production Potential = ~11-18 TAFY

- Available Recharge Capacity

- None
- Need new injection wells

# West Coast (0-23 TAFY)

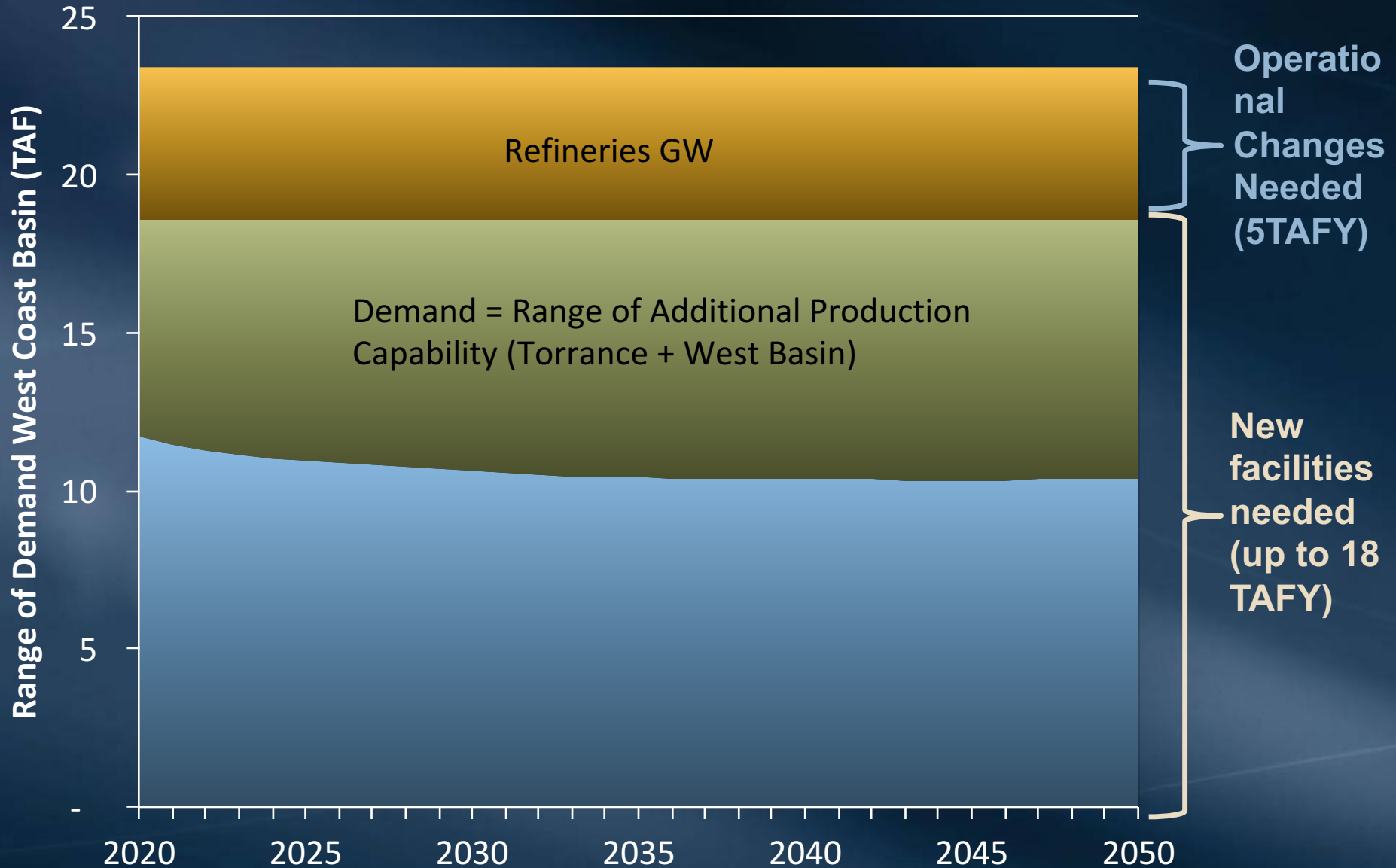

# Groundwater Production Potential

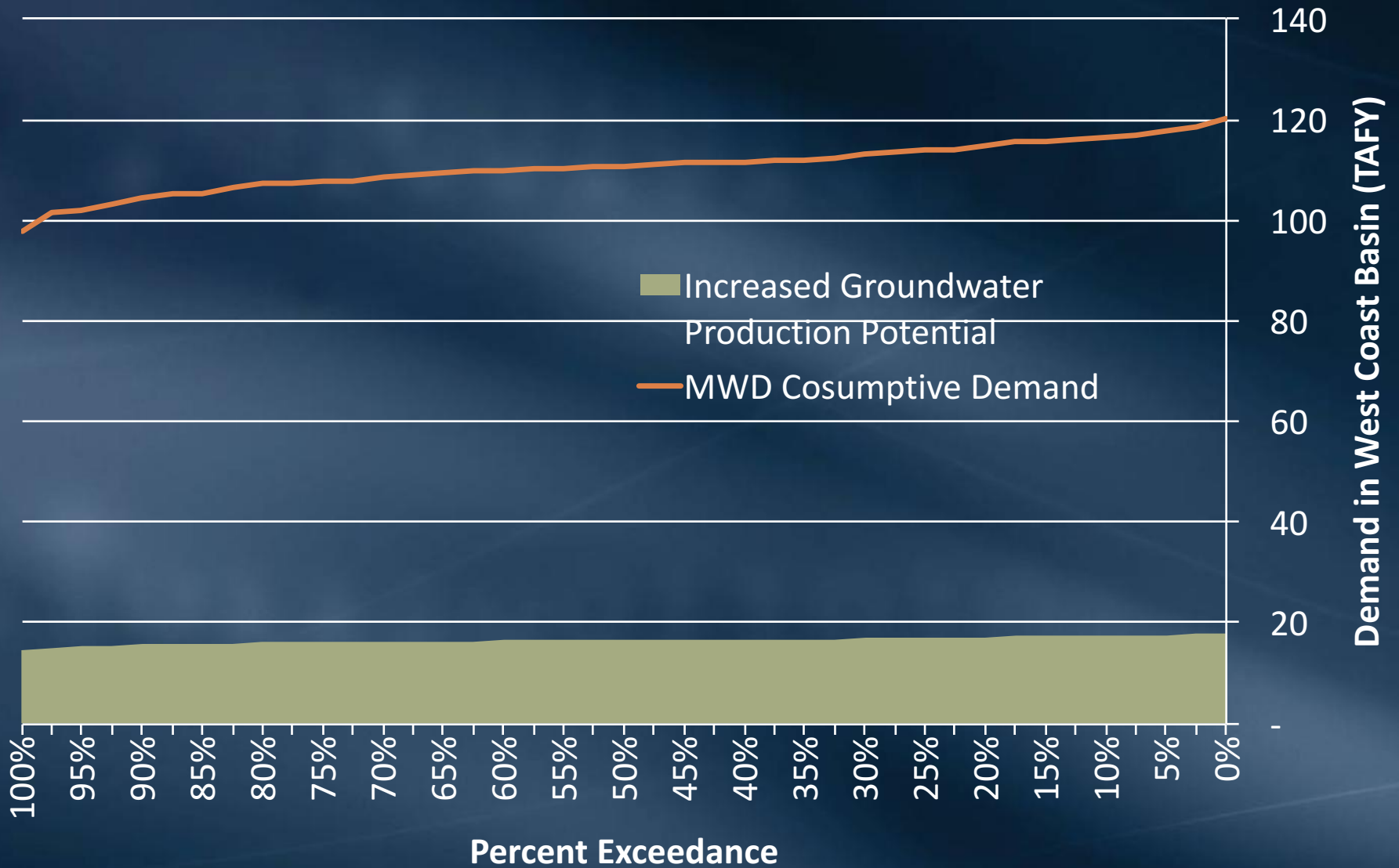



# Model Results: Base Case

Recharge in MFB does not reach LA Forebay

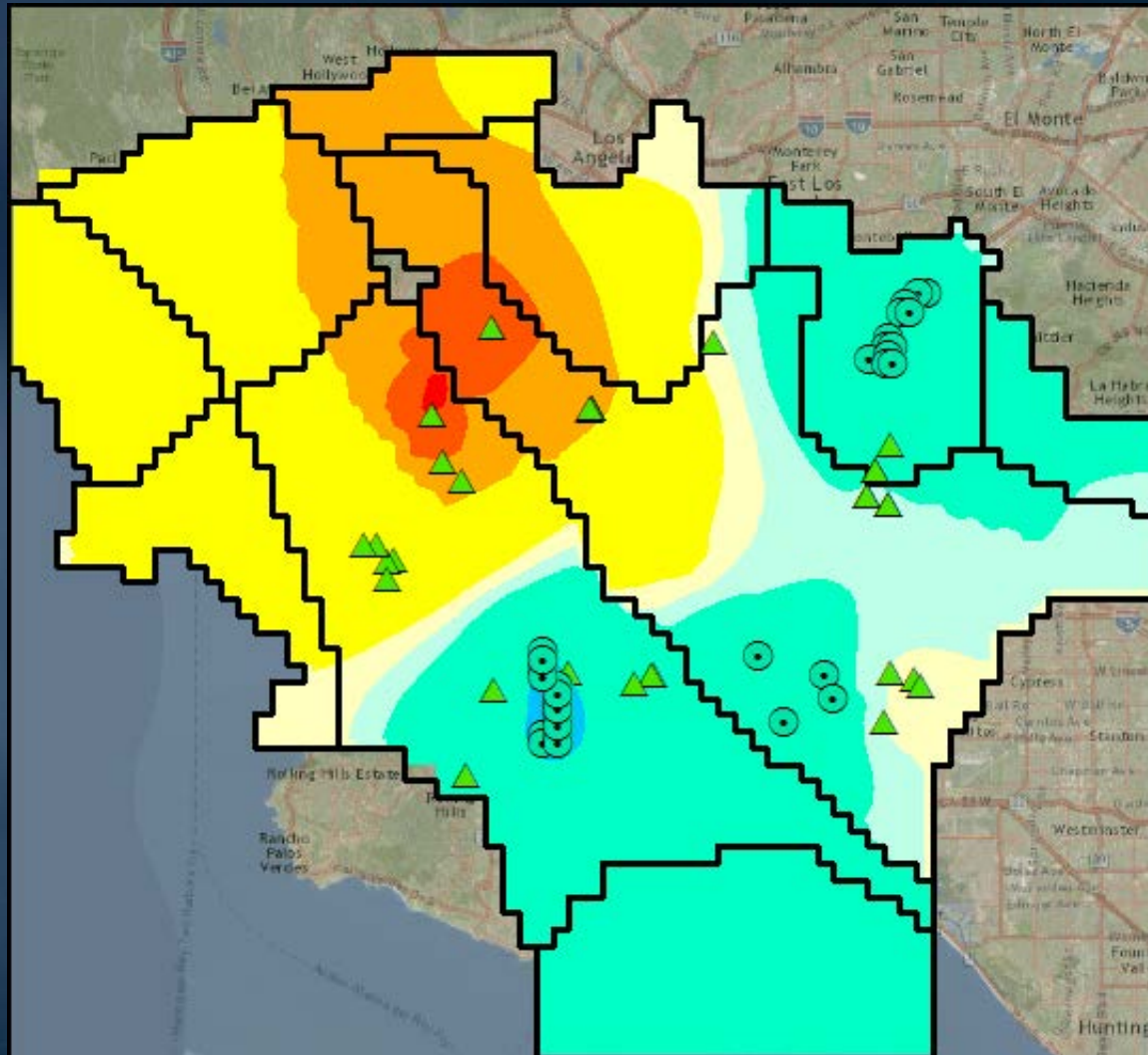

Model Forecasted Head Difference At 40 Years (Feet)

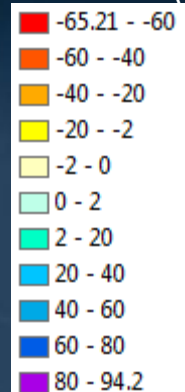

# Model Results: Alternative 1

## Recharge moved to LA Forebay

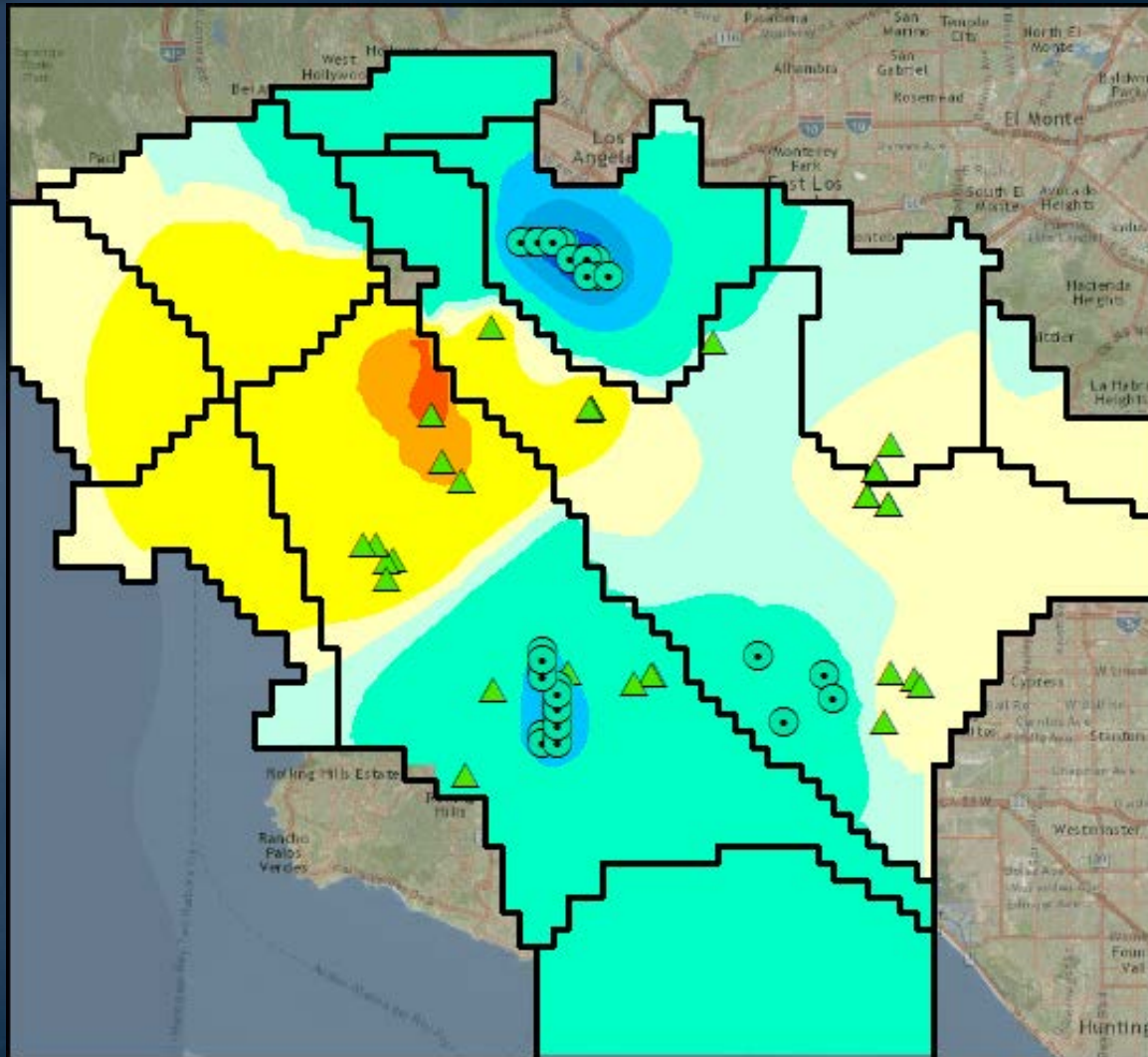

Model Forecasted  
Head Difference  
At 40 Years (Feet)

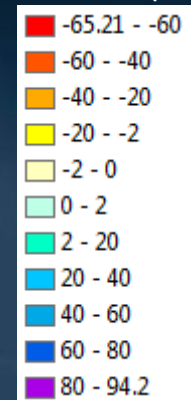

# Model Results: Change in Storage

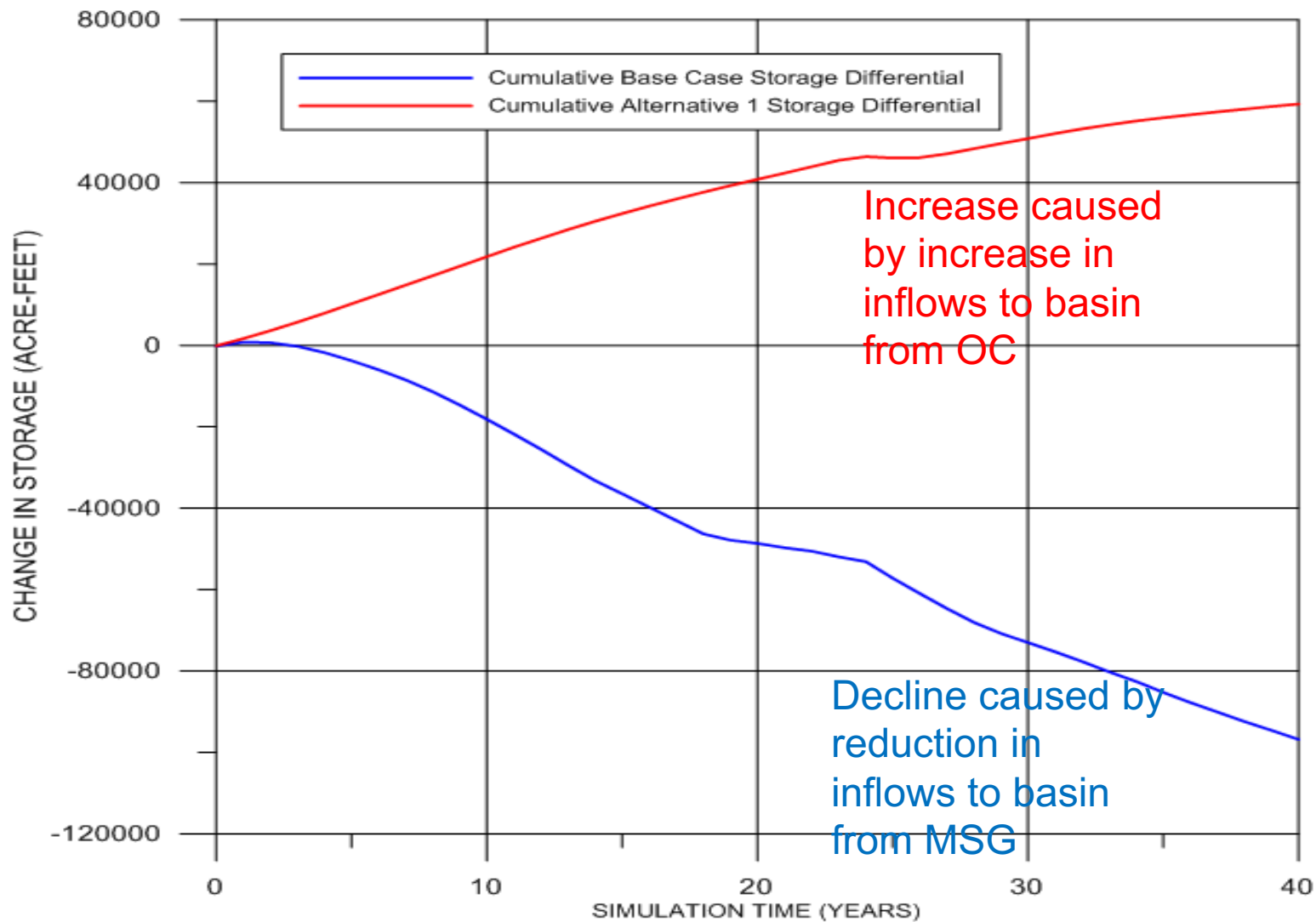

# Summary

# Base Case Normal (150 MGD)

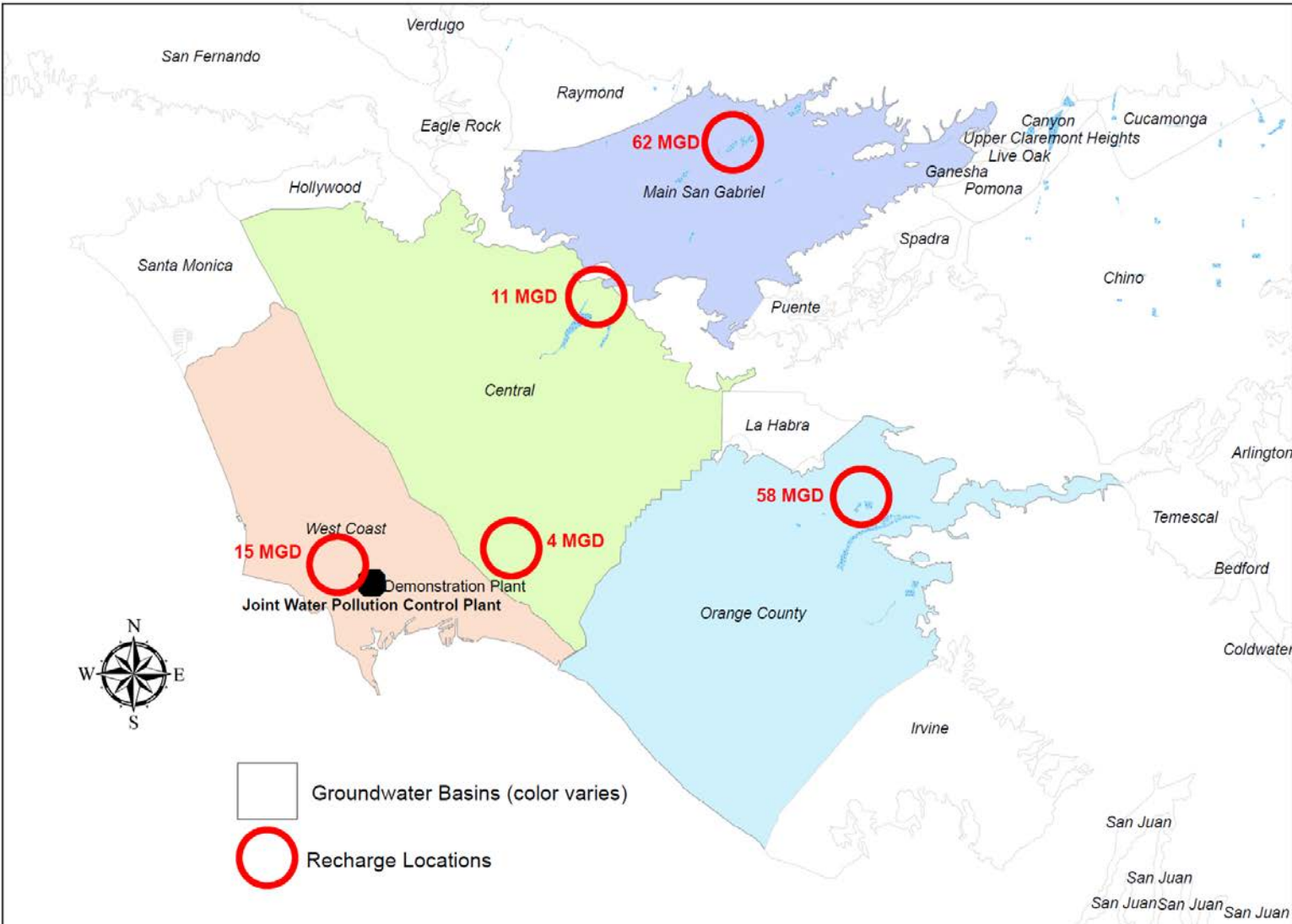

Base Case - Normal Operation

# Base Case Wet Period (110MGD)

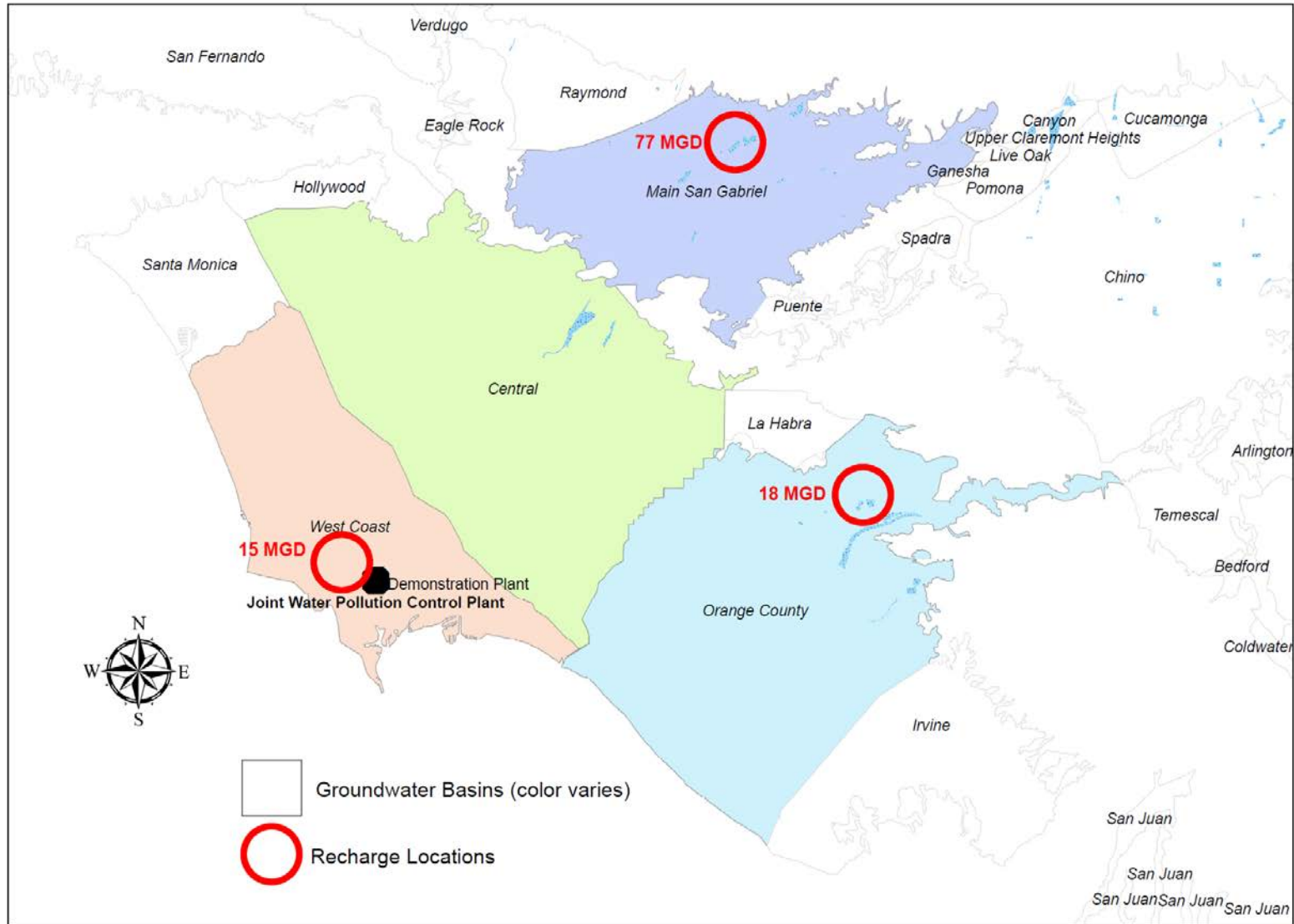

Base Case - Wet Period Operation

# Base Case (110-150 MGD)

Groundwater Basin	Member Agency	Recharge Location	Amount 85% of the time (TAFY)	Amount 15% of the time (TAFY)	Amount for Pipeline Size (MGD)	Notes
Central Basin	Central Basin MWD	Montebello Forebay	3.0	0.0	11.6	Delivered at WN Dam
	Los Angeles	Montebello Forebay	10.0			Alternatives to base case: 10-15 acres of new spreading basins/injection wells
	Long Beach	Existing Injection Wells	4.0	0.0	3.6	Existing injection wells
Main San Gabriel	Upper District & Three Valleys	Santa Fe	70.0	85.0	77.7	Upsized to handle MSG+CB recharge
Orange	MWDOC	GWRS Basins	65.0	20.0	58.0	Using all OCWD recharge basins
West Coast Basin	Torrance & West Basin	New Injection Wells	11.0	11.0	9.8	Will require 10-15 new injection wells
	Los Angeles	Refineries	5.0	5.0	4.5	Alternative to base case: additional injection wells
Total			168.0	121.0	150.0	